



3V 8M-BIT

**SERIAL NOR FLASH WITH
DUAL AND QUAD SPI**

ZBIT CONFIDENTIAL



Contents

FEATURES	4
GENERAL DESCRIPTION	4
1. ORDERING INFORMATION	6
2. BLOCK DIAGRAM	7
3. CONNECTION DIAGRAMS	8
4. SIGNAL DESCRIPTIONS	9
4.1. Serial Data Input (DI) / IO0	9
4.2. Serial Data Output (DO) / IO1	9
4.3. Serial Clock (CLK)	9
4.4. Chip Select (CS#)	9
4.5. Write Protect (WP#) / IO2	10
4.6. HOLD (HOLD#) / IO3	10
4.7. RESET (RESET#) / IO3	10
5. MEMORY ORGANIZATION	11
5.1. Flash Memory Array	11
5.2. Security Registers	12
5.2.1 Security Register 0	12
5.2.2 Serial Flash Discoverable Parameters (SFDP) Address Map	12
5.2.3 SFDP Header Field Definitions	13
5.2.4 JEDEC SFDP Basic SPI Flash Parameter	14
6. FUNCTION DESCRIPTION	19
6.1 SPI Operations	19
6.1.1 SPI Modes	19
6.1.2 Dual SPI Modes	19
6.1.3 Quad SPI Modes	19
6.1.4 Hold Function	20
6.1.5 Software Reset & Hardware RESET# pin	20
6.2. Status Register	20
6.2.1 BUSY	23
6.2.2 Write Enable Latch (WEL)	23
6.2.3 Block Protect Bits (BP2, BP1, BP0)	23
6.2.4 Top / Bottom Block Protect (TB)	23
6.2.5 Sector / Block Protect (SEC)	23
6.2.6 Complement Protect (CMP)	24
6.2.7 The Status Register Protect (SRP0)	24
6.2.8 Erase / Program Suspend Status (SUS)	24
6.2.9 Security Register Lock Bits (LB3, LB2, LB1)	24
6.2.10 Quad Enable (QE)	24
6.2.11 HOLD# or RESET# Pin Function (HRSW)	25
6.2.12 Output Driver Strength (DRV1, DRV0)	25
6.2.13 High Frequency Mode Enable Bit (HFM)	25
6.3. Write Protection	26
6.3.1 Write Protect Features	26
6.3.2 Block Protection Maps	27
6.4. Page Program	29
6.5. Sector Erase, Block Erase and Chip Erase	29
6.6. Polling during a Write, Program or Erase Cycle	29
6.7. Active Power, Stand-by Power and Deep Power-Down Modes	29
7. INSTRUCTIONS	30
7.1 Configuration and Status Commands	34
7.1.1 Read Status Register (05h/35h/15h)	34
7.1.2 Write Enable (06h)	34



7.1.3 Write Enable for Volatile Status Register (50h).....	34
7.1.4 Write Disable (04h).....	35
7.1.5 Write Status Register (01h/31h/11h)	35
7.2 Program and Erase Commands.....	36
7.2.1 Page Program (PP) (02h).....	36
7.2.2 Quad Input Page Program (32h).....	36
7.2.3 Sector Erase (SE) (20h).....	37
7.2.4 Block Erase (BE) (D8h) and Half Block Erase (52h)	37
7.2.5 Chip Erase (CE) (C7h or 60h).....	38
7.2.6 Erase / Program Suspend (75h)	38
7.2.7 Erase / Program Resume (7Ah).....	39
7.3 Read Commands.....	39
7.3.1 Read Data (03h)	39
7.3.2 Fast Read (0Bh)	40
7.3.3 Fast Read Dual Output (3Bh).....	40
7.3.4 Fast Read Quad Output (6Bh)	41
7.3.5 Fast Read Dual I/O (BBh)	41
7.3.6 Fast Read Quad I/O (EBh).....	42
7.3.7 Word Read Quad I/O (E7h).....	43
7.3.8 Octal Word Read Quad I/O (E3h)	44
7.3.9 Set Burst with Wrap (77h)	45
7.4 Reset Commands.....	46
7.4.1 Software Reset Enable (66h)	46
7.4.2 Software Reset (99h)	46
7.5 ID and Security Commands.....	46
7.5.1 Deep Power-down (DP) (B9h)	47
7.5.2 Release Power-down / Device ID (ABh)	47
7.5.3 Read Manufacturer / Device ID (90h)	48
7.5.4 Read Identification (RDID) (9Fh).....	48
7.5.5 Read SFDP Register (5Ah).....	48
7.5.6 Erase Security Registers (44h)	49
7.5.7 Program Security Registers (42h).....	49
7.5.8 Read Security Registers (48h)	50
7.5.9 Read Manufacturer / Device ID Dual I/O (92h).....	50
7.5.10 Read Manufacturer / Device ID Quad I/O (94h)	51
7.5.11 Read Unique ID Number (4Bh)	51
8. ELECTRICAL CHARACTERISTIC	53
8.1. Absolute Maximum Ratings.....	54
8.2. Recommended Operating Ranges.....	54
8.3. DC Characteristics	55
8.4. AC Measurement Conditions.....	55
8.5. AC Electrical Characteristics	56
9. PACKAGE MECHANICAL	58
9.1. Valid Part Numbers.....	58
9.2. SOP8 - 150mil	59
9.3. SOP8 - 208mil	59
9.4. TFBGA24 (5*5 Ball Array)	60
9.5. TFBGA24 (6*4 Ball Array)	60
9.6. TSSOP8 - 173mil.....	61
9.7. DFN8 (2*3*0.55mm)	62
REVISION LIST	63



FEATURES

- **Low power supply operation**
 - Single 2.3V-3.6V supply
- **8M bit Serial Flash**
 - 8 M-bit/1,024K-byte/4,096 pages
 - 256 bytes per programmable page
 - Uniform 4K-byte Sectors, 32K/64K-byte Blocks
- **New Family of SpiFlash Memories**
 - Standard SPI: CLK, CS#, DI, DO, WP#, HOLD# / RESET#
 - Dual SPI: CLK, CS#, DI, DO, WP#, HOLD# / RESET#
 - Quad SPI: CLK, CS#, IO0, IO1, IO2, IO3
 - Software & Hardware Reset
 - Auto-increment Read capability
- **Temperature Ranges**
 - Commercial (-20°C to 85°C)
 - Industrial (-40°C to 85°C)
- **Low power consumption**
 - 12 uA typical standby current, HFM =0
 - 25 uA typical standby current, HFM =1
 - 2 uA typical power down current
- **Efficient “Continuous Read” and Quad Read**
 - Continuous Read with 8/16/32/64-Byte Wrap
 - As few as 8 clocks to address memory
 - Quad Peripheral Interface reduces instruction overhead
- **Flexible Architecture with 4KB sectors**
 - Sector Erase (4K-bytes)
 - Block Erase (32K/64K-bytes)
 - Page Program up to 256 bytes
 - More than 100K erase/program cycles
 - More than 20-year data retention
- **Advanced Security Feature**
 - Software and Hardware Write-Protect
 - Top/Bottom, Complement array protection
 - 64-Bit Unique ID for each device
 - Discoverable parameters(SFDP) register
 - 3X256-Bytes Security Registers with OTP locks
 - Volatile & Non-volatile Status Register Bits
- **High performance program/erase speed**
 - Page program time: 600us typical
 - Sector erase time: 40ms typical
 - Block erase time: 200ms typical
 - Chip erase time: 3s typical
- **Package Options**
 - SOP8 - 150mil/208mil
 - TFBGA24
 - TSSOP8 - 173mil
 - DFN8 (2*3*0.55mm)
 - All Pb-free packages are RoHS compliant

GENERAL DESCRIPTION

The ZB25VQ80A of non-volatile flash memory device supports the standard Serial Peripheral Interface (SPI). Traditional SPI single bit serial input and output (Single I/O or SIO) is supported as well as optional two bit (Dual I/O or DIO) and four bit (quad I/O) serial protocols. This multiple width interface is called SPI Multi-I/O or MIO.

The SPI protocols use only 4 to 6 signals:

- ◆ Chip Select (CS#)
- ◆ Serial Clock (CLK)
- ◆ Serial Data
 - IO0 (DI)
 - IO1 (DO)
 - IO2 (WP#)
 - IO3 (HOLD# / RESET#)

The ZB25VQ80A support the standard Serial Peripheral Interface (SPI), Dual/Quad I/O SPI as well as



2-clocks instruction cycle Quad Peripheral Interface : Serial Clock, Chip Select, Serial Data I/O0 (DI), I/O1 (DO), I/O2 (WP#), and I/O3 (HOLD# / RESET#). SPI clock frequencies of up to 104MHz are supported allowing equivalent clock rates of 208MHz (104MHz x 2) for Dual I/O and 416MHz (104MHz x 4) for Quad I/O when using the Fast Read Dual/Quad I/O . These transfer rates can outperform standard Asynchronous 8 and 16-bit Parallel Flash memories. The Continuous Read Mode allows for efficient memory access with as few as 8-clocks of instruction-overhead to read a 24-bit address, allowing true XIP (execute in place) operation.

A Hold pin, Write Protect pin and programmable write protection, with top or bottom array control, provide further control flexibility. Additionally, the device supports JEDEC standard manufacturer and device ID and SFDP Register, a 64-bit Unique Serial Number and three 256-bytes Security Registers.

The ZB25VQ80A provides an ideal storage solution for systems with limited space, signal connections, and power. These memories' flexibility and performance is better than ordinary serial flash devices. They are ideal for code shadowing to RAM, executing code directly (XIP), and storing reprogrammable data.



1. ORDERING INFORMATION

The ordering part number is formed by a valid combination of the following:

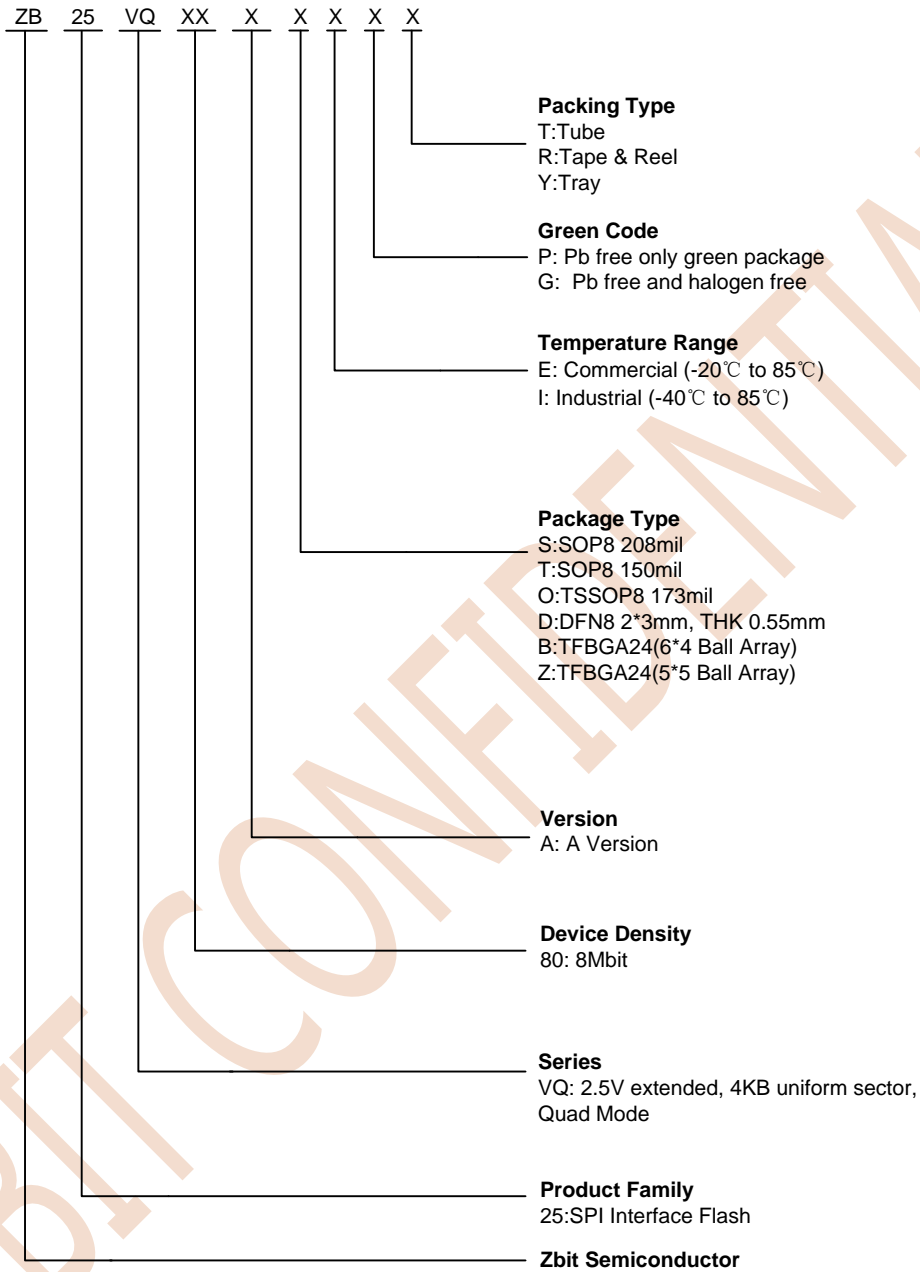

Figure 1.1 Ordering Information



2. BLOCK DIAGRAM

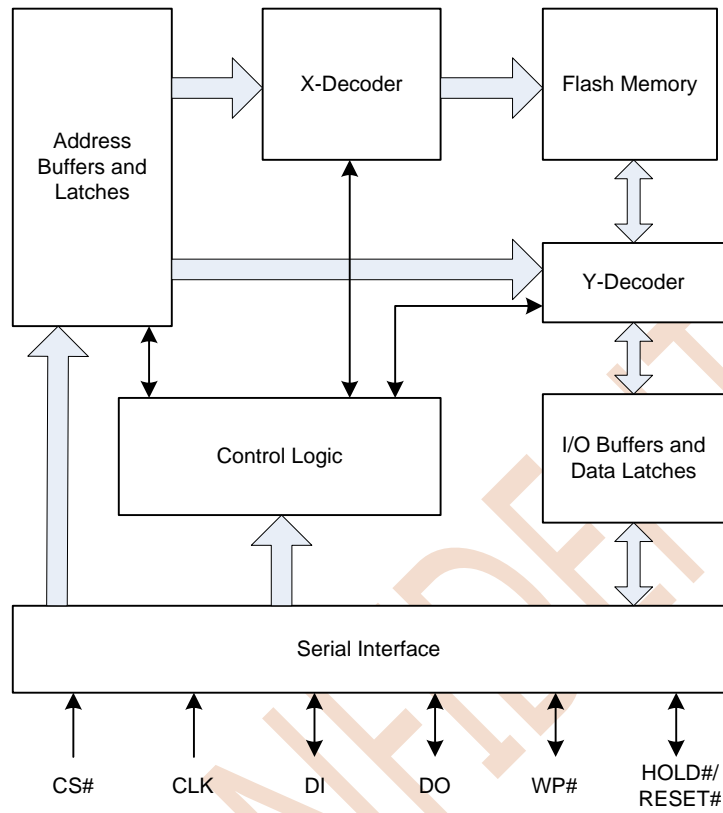

Figure 2.1 Block Diagram



3. CONNECTION DIAGRAMS

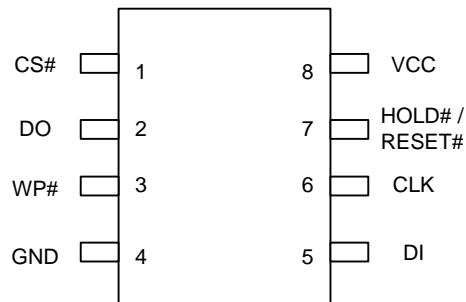

Figure 3.1 SOP8 (150/208mil)/ DIP8 (300mil)

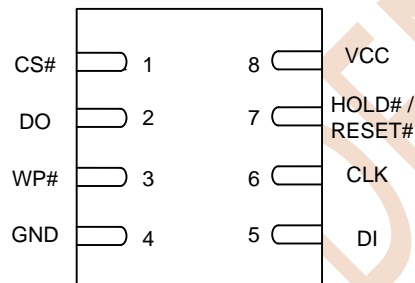

Figure 3.2 DFN8 (5*6 mm)



4. SIGNAL DESCRIPTIONS

Table 4.1 Pin Descriptions

Symbol	Pin Name
CLK	Serial Clock Input
DI(IO0)	Serial Data Input(Data input output 0) ⁽¹⁾
DO(IO1)	Serial Data Output(Data input output 1) ⁽¹⁾
CS#	Chip Enable
WP#(IO2) ⁽³⁾	Write Protect (Data input output 2) ⁽²⁾
HOLD# / RESET# ⁽³⁾ (IO3)	Hold or Reset input(Data input output 3) ⁽²⁾
V _{CC}	Power Supply (2.3-3.6V)
GND	Ground

Notes:

(1) IO0 and IO1 are used for Standard and Dual SPI instructions.

(2) IO0—IO3 are used for QUAD SPI instructions.

(3) WP# and HOLD# / RESET# functions are only available for Standard and Dual SPI.

4.1. Serial Data Input (DI) / IO0

The SPI Serial Data Input (DI) pin is used to transfer data serially into the device. It receives instructions, address and data to be programmed. Data is latched on the rising edge of the Serial Clock (CLK) input pin. The DI pin becomes IO0 - an input and output during Dual and Quad commands for receiving instructions, address, and data to be programmed (values latched on rising edge of serial CLK clock signal) as well as shifting out data (on the falling edge of CLK).

4.2. Serial Data Output (DO) / IO1

The SPI Serial Data Output (DO) pin is used to transfer data serially out of the device. Data is shifted out on the falling edge of the Serial Clock (CLK) input pin. DO becomes IO1 - an input and output during Dual and Quad commands for receiving instructions, addresses, and data to be programmed (values latched on rising edge of serial CLK clock signal) as well as shifting out data (on the falling edge of CLK).

4.3. Serial Clock (CLK)

The SPI Serial Clock Input (CLK) pin provides the timing for serial input and output operations. ("See SPI Mode")

4.4. Chip Select (CS#)

The SPI Chip Select (CS#) pin enables and disables device operation. When CS# is high the device is deselected and the Serial Data Output pins are at high impedance.

When deselected, the devices power consumption will be at standby levels unless an internal erase, program or status register cycle is in progress. When CS# is brought low the device will be selected, power consumption will increase to active levels and instructions can be written to and data read from the device. After power-up, CS# must transition from high to low before a new instruction will be accepted.



4.5. Write Protect (WP#) / IO2

The Write Protect (WP#) pin can be used to prevent the Status Register from being written. Used in conjunction with the Status Register's Block Protect (BP0, BP1 and BP2, TB, SEC, CMP) bits and Status Register Protect (SRP0) bits, a portion or the entire memory array can be hardware protected.

The WP# function is not available when the Quad mode is enabled. The WP# function is replaced by IO2 for input and output during Quad mode for receiving addresses and data to be programmed (values are latched on rising edge of the CLK signal) as well as shifting out data (on the falling edge of CLK).

4.6. HOLD (HOLD#) / IO3

The HOLD# pin allows the device to be paused while it is actively selected. When HRSW bit is '0' (factory default is '0'), the HOLD# pin is enabled. When HOLD# is brought low, while CS# is low, the DO pin will be at high impedance and signals on the DI and CLK pins will be ignored (don't care). When HOLD# is brought high, device operation can resume. The HOLD# function can be useful when multiple devices are sharing the same SPI signals. The HOLD# pin is active low. When the QE bit of Status Register-2 is set for Quad I/O, the HOLD# pin function is not available since this pin is used for IO3.

4.7. RESET (RESET#) / IO3

The RESET# pin allows the device to be reset by the controller. When HRSW bit is '1' (factory default is '0'), the RESET# pin is enabled. Drive RESET# low for a minimum period of ~1us (tRESET*) will interrupt any on-going external/internal operations, regardless the status of other SPI signals (CS#, CLK, DI, DO, WP# and/or HOLD#). The Hardware Reset function is only available for standard SPI and Dual SPI operation, when QE=0, the IO3 pin can be configured either as a HOLD# pin or as a RESET# pin depending on Status Register setting, when QE=1, this pin is the Serial Data IO (IO3) for Quad I/O operation.



5. MEMORY ORGANIZATION

5.1. Flash Memory Array

The ZB25VQ80A memory is organized as:

- 1,048,576bytes
- Uniform Sector Architecture 16 blocks of 64-Kbyte
- 256 sectors of 4-Kbyte
- 4, 096 pages (256 bytes each)

Each page can be individually programmed (bits are programmed from 1 to 0). The device is Sector, Block or Chip Erasable but not Page Erasable.

Table 5.1⁽¹⁾ Memory Organization(ZB25VQ80A)

Block/ Security Register/SFDP	Sector	Address range	
Security Register 3	-	003000H	0030FFH
Security Register 2	-	002000H	0020FFH
Security Register 1	-	001000H	0010FFH
Security Register 0 (SFDP)	-	000000H	0000FFH
Block 15	255	0FF000H	0FFFFFFH

Block 14	240	0F0000H	0F0FFFH

Block 14	239	0EF000H	0EFFFFH

Block 14	224	0E0000H	0E0FFFH

.....

.....

Block 2	47	02F000H	02FFFFH

Block 1	32	020000H	020FFFH

Block 1	31	01F000H	01FFFFH

Block 1	16	010000H	010FFFH

Block 0	15	00F000H	00FFFFH

Block 0	0	000000H	000FFFH

Notes:

(1) These are condensed tables that use a couple of sectors as references. There are address ranges that are not explicitly listed. All 4-kB sectors have the pattern XXX000h-XXXXFFh.



5.2. Security Registers

The ZB25VQ80A provides four 256-byte Security Registers. Each register can be used to store information that can be permanently protected by programming One Time Programmable (OTP) lock bits in Status Register-2.

Register 0 is used by ZBIT to store and protect the Serial Flash Discoverable Parameters (SFDP) information that is also accessed by the Read SFDP command. See Table 5.1.

The three additional Security Registers can be erased, programmed, and protected individually. These registers may be used by system manufacturers to store and permanently protect security or other important information separate from the main memory array.

5.2.1 Security Register 0

Serial Flash Discoverable Parameters (SFDP — JEDEC JESD216B):

This document defines the Serial Flash Discoverable Parameters (SFDP) revision B data structure for ZB25VQ80A family.

The Read SFDP (RSFDP) command (5Ah) reads information from a separate flash memory address space for device identification, feature, and configuration information, in accord with the JEDEC JESD216B standard for Serial Flash Discoverable Parameters.

The SFDP data structure consists of a header table that identifies the revision of the JESD216 header format that is supported and provides a revision number and pointer for each of the SFDP parameter tables that are provided. The parameter tables follow the SFDP header. However, the parameter tables may be placed in any physical location and order within the SFDP address space. The tables are not necessarily adjacent nor in the same order as their header table entries.

The SFDP header points to the following parameter tables:

- Basic Flash
 - This is the original SFDP table.

The physical order of the tables in the SFDP address space is: SFDP Header, and Basic Flash. The SFDP address space is programmed by ZBIT and read-only for the host system.

5.2.2 Serial Flash Discoverable Parameters (SFDP) Address Map

The SFDP address space has a header starting at address zero that identifies the SFDP data structure and provides a pointer to each parameter. One Basic Flash parameter is mandated by the JEDEC JESD216B standard.

Table 5.2 SFDP Overview Map — Security Register 0

Byte Address	Description
0000h	Location zero within JEDEC JESD216B SFDP space – start of SFDP header
0010h	Undefined space reserved for future SFDP header
0030h	Start of SFDP parameter
...	Remainder of SFDP JEDEC parameter followed by undefined space
006Fh	End of SFDP space
0070h to 00FFh	Reserved space



5.2.3 SFDP Header Field Definitions

Table 5.3 SFDP Header

SFDP Byte Address	SFDP Dword Name	Data	Description
00h	SFDP Header 1st DWORD	53h	This is the entry point for Read SFDP (5Ah) command i.e. location zero within SFDP space ASCII "S"
01h		46h	ASCII "F"
02h		44h	ASCII "D"
03h		50h	ASCII "P"
04h	SFDP Header 2nd DWORD	06h	SFDP Minor Revision (06h = JEDEC JESD216 Revision B) – This revision is backward compatible with all prior minor revisions. Minor revisions are changes that define previously reserved fields, add fields to the end, or that clarify definitions of existing fields. Increments of the minor revision value indicate that previously reserved parameter fields may have been assigned a new definition or entire Dwords may have been added to the parameter table. However, the definition of previously existing fields is unchanged and therefore remains backward compatible with earlier SFDP parameter table revisions. Software can safely ignore increments of the minor revision number, as long as only those parameters the software was designed to support are used i.e. Previously reserved fields and additional Dwords must be masked or ignored. Do not do a simple compare on the minor revision number, looking only for a match with the revision number that the software is designed to handle. There is no problem with using a higher number minor revision.
05h		01h	SFDP Major Revision – This is the original major revision. This major revision is compatible with all SFDP reading and parsing software.
06h		00h	Number of Parameter Headers (zero based, 00h = 1 parameters)
07h		FFh	Unused
08h	Parameter Header 0 1st DWORD	00h	Parameter ID LSB (00h = JEDEC SFDP Basic SPI Flash Parameter)
09h		06h	Parameter Minor Revision (00h = JESD216) –This older revision parameter header is provided for any legacy SFDP reading and parsing software that requires seeing a minor revision 6 parameter header. SFDP software designed to handle later minor revisions should continue reading parameter headers looking for a higher numbered minor revision that contains additional parameters for that software revision.
0Ah		01h	Parameter Major Revision (01h = The original major revision - all SFDP software is compatible with this major revision).
0Bh		10h	Parameter Table Length (in double words = Dwords = 4-byte units) 10h = 16 Dwords
0Ch	Parameter Header 0 2nd DWORD	30h	Parameter Table Pointer Byte 0 (Dword = 4-byte aligned) JEDEC Basic SPI Flash parameter byte offset = 30h
0Dh		00h	Parameter Table Pointer Byte 1
0Eh		00h	Parameter Table Pointer Byte 2
0Fh		FFh	Parameter ID MSB (FFh = JEDEC defined legacy Parameter ID)



5.2.4 JEDEC SFDP Basic SPI Flash Parameter

Table 5.4 Basic SPI Flash Parameter, JEDEC SFDP Rev B (Sheet 1 of 5)

SFDP Parameter Relative Byte Address	SFDP Dword Name	Data	Description
30h	JEDEC Basic Flash Parameter Dword-1	E5h	Start of SFDP JEDEC parameter Bits 7:5 = unused = 111b Bit 4:3 = 05h is volatile status register write instruction and status register is default non-volatile= 00b Bit 2 = Program Buffer > 64 bytes = 1 Bits 1:0 = Uniform 4-kB erase is supported throughout the device = 01b
31h		20h	Bits 15:8 = Uniform 4-kB erase instruction = 20h
32h		F1h	Bit 23 = Unused = 1b Bit 22 = Supports QOR Read (1-1-4), Yes = 1b Bit 21 = Supports QIO Read (1-4-4), Yes = 1b Bit 20 = Supports DIO Read (1-2-2), Yes = 1b Bit 19 = Supports DDR, No = 0 b Bit 18:17 = Number of Address Bytes 3 only = 00b Bit 16 = Supports SIO and DIO Yes = 1b Binary Field: 1-1-1-1-0-00-1 Nibble Format: 1111_0001 Hex Format: F1
33h		FFh	Bits 31:24 = Unused = FFh
34h	JEDEC Basic Flash Parameter Dword-2	FFh	Density in bits, zero based, 2 Mb = 001FFFFFFh 4 Mb = 003FFFFFFh 8 Mb = 007FFFFFFh
35h		FFh	
36h		7Fh	
37h		00h	
38h	JEDEC Basic Flash Parameter Dword-3	44h	Bits 7:5 = number of QIO (1-4-4) Mode cycles = 010b Bits 4:0 = number of Fast Read QIO Dummy cycles = 00100b for default latency code
39h		EBh	Fast Read QIO (1-4-4) instruction code
3Ah		08h	Bits 23:21 = number of Quad Out (1-1-4) Mode cycles = 000b Bits 20:16 = number of Quad Out Dummy cycles = 01000b for default latency code
3Bh		6Bh	Quad Out (1-1-4) instruction code
3Ch	JEDEC Basic Flash Parameter Dword-4	08h	Bits 7:5 = number of Dual Out (1-1-2) Mode cycles = 000b Bits 4:0 = number of Dual Out Dummy cycles = 01000b for default latency code
3Dh		3Bh	Dual Out (1-1-2) instruction code
3Eh		80h	Bits 23:21 = number of Dual I/O Mode cycles = 100b Bits 20:16 = number of Dual I/O Dummy cycles = 00000b for default latency code
3Fh		BBh	Dual I/O instruction code
40h	JEDEC Basic Flash Parameter Dword-5	EFh	Bits 7:5 RFU = 111b Bit 4 = QPI (4-4-4) fast read commands not supported = 0b Bits 3:1 RFU = 111b Bit 0 = Dual All not supported = 0b
41h		FFh	Bits 15:8 = RFU = FFh
42h		FFh	Bits 23:16 = RFU = FFh
43h		FFh	Bits 31:24 = RFU = FFh
44h	JEDEC Basic Flash Parameter Dword-6	FFh	Bits 7:0 = RFU = FFh
45h		FFh	Bits 15:8 = RFU = FFh
46h		FFh	Bits 23:21 = number of Dual All Mode cycles = 111b Bits 20:16 = number of Dual All Dummy cycles = 11111b
47h		FFh	Dual All instruction code



Table 5.4 Basic SPI Flash Parameter, JEDEC SFDP Rev B (Sheet 2 of 5)

SFDP Parameter Relative Byte Address	SFDP Dword Name	Data	Description
48h	JEDEC	0Ch	Erase Type 1 size 2^N Bytes = 4 kB = 0Ch (for Uniform 4 kB)
49h	Basic Flash Parameter	20h	Erase Type 1 instruction
4Ah		0Fh	Erase Type 2 size 2^N Bytes = 32 kB = 0Fh (for Uniform 32 kB)
4Bh	Dword-8	52h	Erase Type 2 instruction
4Ch	JEDEC	10h	Erase Type 3 size 2^N Bytes = 64 kB = 10h (for Uniform 64 kB)
4Dh	Basic Flash Parameter	D8h	Erase Type 3 instruction
4Eh		00h	Erase Type 4 size 2^N Bytes = not supported = 00h
4Fh	Dword-9	FFh	Erase Type 4 instruction = not supported = FFh
50h	JEDEC Basic Flash Parameter Dword-4	13h	Bits 31:30 = Erase Type 4 Erase, Typical time units (00b: 1 ms, 01b: 16 ms, 10b: 128 ms, 11b:1 s) = RFU = 11b Bits 29:25 = Erase Type 4 Erase, Typical time count = RFU = 11111b (typ erase time = (count+1) * units) = RFU = 11111
51h		42h	Bits 24:23 = Erase Type 3 Erase, Typical time units (00b: 1 ms, 01b: 16 ms, 10b: 128 ms, 11b:1 s) = RFU = 01b
52h		ADh	Bits 22:18 = Erase Type 3 Erase, Typical time count = 01011b (typ erase time = (count +1) *units) = 12×16 ms = 200ms Bits 17:16 = Erase Type 2 Erase, Typical time units (00b: 1 ms, 01b: 16 ms, 10b: 128 ms, 11b:1 s) = 16 ms = 01b Bits 15:11 = Erase Type 2 Erase, Typical time count = 01000b (typ erase time = (count +1) *units) = 9×16 ms = 150 ms Bits 10:9 = Erase Type 1 Erase, Typical time units (00b: 1 ms, 01b: 16 ms, 10b: 128 ms, 11b: 1s) = 16ms = 01b Bits 8:4 = Erase Type 1 Erase, Typical time count = 00001b (typ erase time = (count +1) *units) = 2×16 ms = 35 ms Bits 3:0 = Count = (Max Erase time / (2 * Typical Erase time))- 1 = 0011b Multiplier from typical erase time to maximum erase time = 8x multiplier Max Erase time = $2 \times (\text{Count} + 1) \times \text{Typ Erase time}$ Binary Fields: 1111111_0101011_0101000_0100001_0011 Nibble Format: 1111_1110_1010_1101_0100_0010_0001_0011 Hex Format: FE_AD_42_13
53h		FEh	



Table 5.4 Basic SPI Flash Parameter, JEDEC SFDP Rev B (Sheet 3 of 5)

SFDP Parameter Relative Byte Address	SFDP Dword Name	Data	Description
54h	JEDEC Basic Flash Parameter Dword-11	81h	Bits 23 = Byte Program Typical time, additional byte units (0b:1 μ s, 1b:8 μ s) = 1 μ s = 0b
55h		65h	Bits 22:19 = Byte Program Typical time, additional byte count, (count+1)*units, count = 0010b, (typ Program time = (count +1) * units) = 3*1 μ s = 3 μ s Bits 18 = Byte Program Typical time, first byte units (0b:1 μ s, 1b:8 μ s) = 8 μ s = 1b Bits 17:14 = Byte Program Typical time, first byte count, (count+1)*units, count = 0001b, (typ Program time = (count +1) * units) = 2*8 μ s = 16 μ s Bits 13 = Page Program Typical time units (0b:8 μ s, 1b:64 μ s) = 64 μ s = 1b Bits 12:8 = Page Program Typical time count, (count+1)*units, count = 00101b, (typ Program time = (count +1) * units) = 6*64 μ s = 400 μ s Bits 7:4 = N = 1000b, Page size= 2N = 256B page Bits 3:0 = Count = 0001b = (Max Page Program time / (2 * Typ Page Program time))- 1 Multiplier from typical Page Program time to maximum Page Program time = 4x multiplier Max Page Program time = 2*(Count +1)*Typ Page Program time Binary Fields: 0-0010-1-0001-1-00101-1000-0001 Nibble Format: 0001_0100_0110_0101_1000_0001 Hex Format: 14_65_81
56h		14h	8 Mb = 1010_1011b = ABh Bit 31 Reserved = 1b Bits 30:29 = Chip Erase, Typical time units (00b: 16 ms, 01b: 256 ms, 10b: 4 s, 11b: 64 s) = 256ms= 01b Bits 28:24 = Chip Erase, Typical time count, (count+1)*units, count = 01101b, (typ Program time = (count +1) * units) = 12*256ms = 3s
57h		ABh	
58h	JEDEC Basic Flash Parameter Dword-12	EDh	Bit 31 = Suspend and Resume supported = 0b
59h		63h	Bits 30:29 = Suspend in-progress erase max latency units (00b: 128ns, 01b: 1us, 10b: 8 μ s, 11b: 64 μ s) = 1 μ s= 01b Bits 28:24 = Suspend in-progress erase max latency count = 10011b, max erase suspend latency = (count +1) * units = 20*1 μ s = 20 μ s Bits 23:20 = Erase resume to suspend interval count = 0001b, interval = (count +1) * 64 μ s = 2* 64 μ s = 128 μ s Bits 19:18 = Suspend in-progress program max latency units (00b: 128ns, 01b: 1us, 10b: 8 μ s, 11b: 64 μ s) = 1 μ s= 01b Bits 17:13 = Suspend in-progress program max latency count = 10011b, max erase suspend latency = (count +1) * units = 20*1 μ s = 20 μ s Bits 12:9 = Program resume to suspend interval count = 0001b, interval = (count +1) * 64 μ s = 2 * 64 μ s = 128 μ s Bit 8 = RFU = 1b Bits 7:4 = Prohibited operations during erase suspend = xxx0b: May not initiate a new erase anywhere (erase nesting not permitted) + xx1xb: May not initiate a page program in the erase suspended sector size + x1xxb: May not initiate a read in the erase suspended sector size + 1xxxb: The erase and program restrictions in bits 5:4 are sufficient = 1110b Bits 3:0 = Prohibited Operations During Program Suspend = xxx1b: May not initiate a new erase in the program suspended page size + xx0xb: May not initiate a new page program anywhere (program nesting not permitted) + x1xxb: May not initiate a read in the program suspended page size + 1xxxb: The erase and program restrictions in bits 1:0 are sufficient = 1101b Binary Fields: 0-01-10011-0001-01-10011-0001-1-1110-1101 Nibble Format: 0011_0011_0001_0110_0110_0011_1110_1101 Hex Format: 33_16_63_ED
5Ah		16h	
5Bh		33h	



Table 5.4 Basic SPI Flash Parameter, JEDEC SFDP Rev B (Sheet 4 of 5)

SFDP Parameter Relative Byte Address	SFDP Dword Name	Data	Description
5Ch	JEDEC Basic Flash Parameter Dword-13	7Ah	Bits 31:24 = Erase Suspend Instruction = 75h Bits 23:16 = Erase Resume Instruction = 7Ah Bits 15:8 = Program Suspend Instruction = 75h Bits 7:0 = Program Resume Instruction = 7Ah
5Dh		75h	
5Eh		7Ah	
5Fh		75h	
60h	JEDEC Basic Flash Parameter Dword-14	F7h	Bit 31 = Deep Power-Down Supported = 0 Bits 30:23 = Enter Deep Power-Down Instruction = B9h Bits 22:15 = Exit Deep Power-Down Instruction = ABh Bits 14:13 = Exit Deep Power-Down to next operation delay units = (00b: 128 ns, 01b: 1 μs, 10b: 8 μs, 11b: 64 μs) = 1 μs = 01b Bits 12:8 = Exit Deep Power-Down to next operation delay count = 00010b, Exit Deep Power-Down to next operation delay = (count+1)*units = 3*1 μs=3 μs Bits 7:4 = RFU = 1111b Bit 3:2 = Status Register Polling Device Busy = 01b: Legacy status polling supported = Use legacy polling by reading the Status Register with 05h instruction and checking WIP bit[0] (0=ready; 1=busy). Bits 1:0 = RFU = 11b Binary Fields: 0-10111001-10101011-01-00010-1111-01-11 Nibble Format: 0101_1100_1101_0101_1010_0010_1111_0111 Hex Format: 5C_D5_A2_F7
61h		A2h	
62h		D5h	
63h		5Ch	
64h	JEDEC Basic Flash Parameter Dword-15	19h	Bits 31:24 = RFU = FFh Bit 23 = Hold and WP Disable = set QE(bit 1 of SR2) high = 1b Bits 22:20 = Quad Enable Requirements = 101b: QE is bit 1 of the status register 2. Status register 1 is read using Read Status instruction 05h. Status register 2 is read using instruction 35h. QE is set via Write Status instruction 01h with two data bytes where bit 1 of the second byte is one. It is cleared via Write Status with two data bytes where bit 1 of the second byte is zero. Bits 19:16 0-4-4 Mode Entry Method = xxx1b: Mode Bits[7:0] = A5h Note: QE must be set prior to using this mode + x1xxb: Mode Bits[7:0] = Axh + 1xxxb: RFU = 1101b Bits 15:10 0-4-4 Mode Exit Method = xx_1xxb: Mode Bits[7:0] = 00h will terminate this mode at the end of the current read operation + xx_1xxb: Input Fh (mode bit reset) on DQ0-DQ3 for 8 clocks. This will terminate the mode prior to the next read operation. + 11_x1xx: RFU = 111101b Bit 9 = 0-4-4 mode supported = 1 Bits 8:4 = 4-4-4 mode enable sequences = 0_0001b: set QE per QER description above, then issue instruction 38h Bits 3:0 = 4-4-4 mode disable sequences = xxx1b: issue FFh instruction + 1xxxb: issue the Soft Reset 66/99 sequence = 1001b Binary Fields: 11111111-1-101-1101-111101-1-00001-1001 Nibble Format: 1111_1111-1101-1101-1111_0110_0001-1001 Hex Format: FF_DD_F6_19
65h		F6h	
66h		DDh	
67h		FFh	



Table 5.4 Basic SPI Flash Parameter, JEDEC SFDP Rev B (Sheet 5 of 5)

SFDP Parameter Relative Byte Address	SFDP Dword Name	Data	Description
68h	JEDEC Basic Flash Parameter Dword-16	E8h	Bits 31:24 = Enter 4-Byte Addressing = xxxx_xxx1b:issue instruction B7 (preceding write enable not required) + xx1x_xxxx: Supports dedicated 4-byte address instruction set. Consult vendor data sheet for the instruction set definition or look for 4-byte Address Parameter Table. + 1xxx_xxxx: Reserved = 10000000b not supported Bits 23:14 = Exit 4-byte Addressing = xx_xxxx_xxx1b:issue instruction E9h to exit 4-byte address mode (Write enable instruction 06h is not required) + xx_xx1x_xxxx: Hardware reset + xx_x1xx_xxxx: Software reset (see bits 13:8 in this DWORD) + xx_1xxx_xxxx: Power cycle + x1_xxxx_xxxx: Reserved + 1x_xxxx_xxxx: Reserved = 11_0000_0000b not supported Bits 13:8 = Soft Reset and Rescue Sequence Support = x1_xxxx: issue reset enable instruction 66h, then issue reset instruction 99h. The reset enable, reset sequence may be issued on 1,2, or 4 wires depending on the device operating mode + 1x_xxxx: exit 0-4-4 mode is required prior to other reset sequences above if the device may be operating in this mode. = 11_0000b Bit 7 = RFU = 1 Bits 6:0 = Volatile or Non-Volatile Register and Write Enable Instruction for Status Register 1 = xxx_1xxx: Non-Volatile/Volatile status register 1 powers-up to last written value in the nonvolatile status register, use instruction 06h to enable write to non-volatile status register. Volatile status register may be activated after power-up to override the non-volatile status register, use instruction 50h to enable write and activate the volatile status register. + x1x_xxxx: Reserved + 1xx_xxxx: Reserved = 1101000b Binary Fields: 10000000-1100000000-110000-1-1101000 Nibble Format: 1000_0000_1100_0000_0011_0000_1110_1000 Hex Format: 80_C0_30_E8
69h		30h	
6Ah		C0h	
6Bh		80h	

6. FUNCTION DESCRIPTION

6.1 SPI Operations

6.1.1 SPI Modes

The ZB25VQ80A can be driven by an embedded microcontroller (bus master) in either of the two following clocking modes.

◆ **Mode 0** with Clock Polarity (CPOL) = 0 and, Clock Phase (CPHA) = 0

◆ **Mode 3** with CPOL = 1 and, CPHA = 1

For these two modes, input data is always latched in on the rising edge of the CLK signal and the output data is always available on the falling edge of the CLK clock signal.

The difference between the two modes is the clock polarity when the bus master is in standby mode and not transferring any data.

◆ CLK will stay at logic low state with CPOL = 0, CPHA = 0

◆ CLK will stay at logic high state with CPOL = 1, CPHA = 1

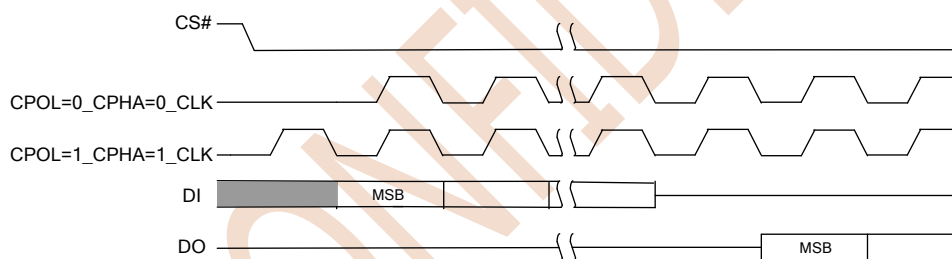

Figure 6.1 SPI Modes

Timing diagrams throughout the rest of the document are generally shown as both mode 0 and 3 by showing CLK as both high and low at the fall of CS#. In some cases a timing diagram may show only mode 0 with CLK low at the fall of CS#. In such case, mode 3 timing simply means clock is high at the fall of CS# so no CLK rising edge set up or hold time to the falling edge of CS# is needed for mode 3.

CLK cycles are measured (counted) from one falling edge of CLK to the next falling edge of CLK. In mode 0 the beginning of the first CLK cycle in a command is measured from the falling edge of CS# to the first falling edge of CLK because CLK is already low at the beginning of a command.

6.1.2 Dual SPI Modes

The ZB25VQ80A supports Dual SPI Operation when using the Fast Read Dual Output (3Bh) and Fast Dual I/O (BBh) instruction. These features allow data to be transferred from the device at twice the rate possible with the standard SPI. These instructions are ideal for quickly downloading code to RAM upon Power-up (code-shadowing) or for executing non-speed-critical code directly from the SPI bus (XIP). When using Dual SPI commands, the DI and DO pins become bidirectional I/O pins: IO0 and IO1.

6.1.3 Quad SPI Modes

The ZB25VQ80A supports Quad SPI operation when using the Fast Read Quad Output (6Bh), Fast Read Quad I/O (EBh) instruction, Word Read Quad I/O (E7h), and Octal Word Read Quad I/O (E3h). These instructions allow data to be transferred to or from the device four times the rate of ordinary Serial Flash. The Quad Read instructions offer a significant improvement in continuous and random access transfer rates



allowing fast code-shadowing to RAM or execution directly from the SPI bus (XIP). When using Quad SPI instructions, the DI and DO pins become bidirectional IO0 and IO1, and the WP# and HOLD# / RESET# pins become IO2 and IO3 respectively. Quad SPI instructions require the non-volatile Quad Enable bit (QE) in Status Register-2 to be set.

6.1.4 Hold Function

For Standard SPI and Dual SPI operations, the HOLD# / RESET# (IO3) signal allows the device interface operation to be paused while it is actively selected (when CS# is low). The Hold function may be useful in cases where the SPI data and clock signals are shared with other devices. For example, if the page buffer is only partially written when a priority interrupt requires use of the SPI bus, the Hold function can save the state of the interface and the data in the buffer so programming command can resume where it left off once the bus is available again. The Hold function is only available for standard SPI and Dual SPI operation, not during Quad SPI.

To initiate a Hold condition, the device must be selected with CS# low. A Hold condition will activate on the falling edge of the HOLD# signal if the CLK signal is already low. If the CLK is not already low the Hold condition will activate after the next falling edge of CLK. The Hold condition will terminate on the rising edge of the HOLD# signal if the CLK signal is already low. If the CLK is not already low the Hold condition will terminate after the next falling edge of CLK. During a Hold condition, the Serial Data Output, (DO) or IO0 and IO1, are high impedance and Serial Data Input, (DI) or IO0 and IO1, and Serial Clock (CLK) are ignored. The Chip Select (CS#) signal should be kept active (low) for the full duration of the Hold operation to avoid resetting the internal logic state of the device.

6.1.5 Software Reset & Hardware RESET# pin

The ZB25VQ80A can be reset to the initial power-on state by a software Reset sequence, either in SPI mode. This sequence must include two consecutive commands: Enable Reset (66h) & Reset (99h). If the command sequence is successfully accepted, the device will take approximately 10us (t_{RST}) to reset. No command will be accepted during the reset period.

ZB25VQ80A can also be configured to utilize a hardware RESET# pin. The HRSW bit in the Status Register-3 is the configuration bit for HOLD# pin function or RESET# pin function. When HRSW=0 (factory default), the pin acts as a HOLD# pin as described above; when HRSW =1, the pin acts as a RESET# pin. Drive the RESET# pin low for a minimum period of ~1us (t_{RESET}^*) will reset the device to its initial power-on state. Any on-going Program/Erase operation will be interrupted and data corruption may happen. While RESET# is low, the device will not accept any command input.

If QE bit is set to 1, the HOLD# or RESET# function will be disabled, the pin will become one of the four data I/O pins.

Hardware RESET# pin has the highest priority among all the input signals. Drive RESET# low for a minimum period of ~1us (t_{RESET}^*) will interrupt any on-going external/internal operations, regardless the status of other SPI signals (CS#, CLK, DI, DO, WP# and/or HOLD#).

Note:

1. While a faster RESET# pulse (as short as a few hundred nanoseconds) will often reset the device, a 1us minimum is recommended to ensure reliable operation.

6.2. Status Register

The Read and Write Status Registers commands can be used to provide status and control of the flash memory device.

Status Register-1 (SR1) and Status Register-2 (SR2) can be used to provide status on the availability of the flash memory array, whether the device is write enabled or disabled, the state of write protection, Quad SPI setting, Security Register lock status, and Erase / Program Suspend status.

SR1 and SR2 contain non-volatile bits in locations SR1[7:2] and SR2[6:0] that control sector protection, OTP Register Protection, Status Register Protection, and Quad mode. Bits located in SR2[7], SR1[1], and



SR1[0] are read only volatile bits for suspend, write enable, and busy status. These are updated by the memory control logic. The SR1[1] write enable bit is set only by the Write Enable (06h) command and cleared by the memory control logic when an embedded operation is completed.

Write access to the non-volatile Status Register bits is controlled by the state of the non-volatile Status Register Protect bits SR1[7] (SRP0), the Write Enable command (06h) preceding a Write Status Registers command, and while Quad mode is not enabled, the WP# pin.

A volatile version of bits SR2[6], SR2[1], and SR1[7:2] that control sector protection and Quad Mode is used to control the behavior of these features after power up. During power up or software reset, these volatile bits are loaded from the non-volatile version of the Status Register bits. The Write Enable for Volatile Status Register (50h) command can be used to write these volatile bits when the command is followed by a Write Status Registers (01h/31h) command. This gives more flexibility to change the system configuration and memory protection schemes quickly without waiting for the typical non-volatile bit write cycles or affecting the endurance of the Status Register non-volatile bits.

Write access to the volatile SR1 and SR2 Status Register bits is controlled by the state of the non-volatile Status Register Protect bits SR1[7] (SRP0), the Write Enable for Volatile Status Register command (50h) preceding a Write Status Registers command, and the WP# pin while Quad mode is not enabled.

Status Register-3 (SR3) is used to configure and provide status on the variable HOLD# or RESET# function, Output Driver Strength, High Frequency Enable Bit and read latency.

Write access to the volatile SR3 Status Register bits is controlled by Write Enable for Volatile Status Register command (50h) preceding a Write Status Register command. The SRP bits do not protect SR3.



Table 6.1 Status Register-1 (SR1)

Bits	Field	Function	Type	Default State	Description
7	SRP0	Status Register Protect 0	Non-volatile and Volatile versions	0	0 = WP# input has no effect or Power Supply Lock Down mode 1 = WP# input can protect the Status Register or OTP Lock Down.
6	SEC	Sector / Block Protect		0	0 = BP2-BP0 protect 64-kB blocks 1 = BP2-BP0 protect 4-kB sectors
5	TB	Top / Bottom protect		0	0 = BP2-BP0 protect from the Top down 1 = BP2-BP0 protect from the Bottom up
4	BP2	Block Protect Bits		0	000b = No protection
3	BP1			0	
2	BP0			0	
1	WEL	Write Enable Latch	Volatile, Read only	0	0 = Not Write Enabled, no embedded operation can start 1 = Write Enabled, embedded operation can start
0	BUSY	Embedded Operation Status	Volatile, Read only	0	0 = Not Busy, no embedded operation in progress 1 = Busy, embedded operation in progress

Table 6.2 Status Register-2 (SR2)

Bits	Field	Function	Type	Default State	Description
7	SUS	Suspend Status	Volatile, Read Only	0	0 = Erase / Program not suspended 1 = Erase / Program suspended
6	CMP	Complement Protect	Non-volatile and Volatile versions	0	0 = Normal Protection Map 1 = Complementary Protection Map
5	LB3	Security Register Lock Bits	OTP	0	OTP Lock Bits 3:0 for Security Registers 3:0 0 = Security Register not protected 1 = Security Register protected
4	LB2			0	
3	LB1			0	
2	Reserve			0	
1	QE	Quad Enable	Non-volatile and Volatile versions	0	0 = Quad Mode Not Enabled, the WP# pin and HOLD# / RESET# are enabled 1 = Quad Mode Enabled, the IO2 and IO3 pins are enabled, and WP# and HOLD# / RESET# functions are disabled
0	Reserve			0	



Table 6.3 Status Register-3 (SR3)

Bits	Field	Function	Type	Default State	Description
7	HRSW ⁽¹⁾	HOLD# or RESET# function	Non-volatile and Volatile versions	0	When HRSW=0, the pin acts as HOLD#; when HRSW=1, the pin acts as RESET#. HRSW functions are only available when QE=0.
6	DRV1 ⁽¹⁾	Output Driver Strength	Volatile	0	The DRV1 & DRV0 bits are used to determine the output driver strength for the Read operations.
5	DRV0 ⁽¹⁾			0	
4	HFM	High Frequency Mode Enable Bit	Non-volatile and Volatile versions	0	0 =High Frequency Mode Disabled 1 =High Frequency Mode Enabled
3	Reserve			0	
2				0	
1				0	
0				0	

Note:

1.Default state for these three bits could be modified. please contact sales.

6.2.1 BUSY

BUSY is a read only bit in the status register (SR1[0]) which is set to a “1” state when the device is executing a Page Program, Sector Erase, Block Erase, Chip Erase or Write Status Register instruction. During this time the device will ignore further instructions except for the Read Status Register instruction (see t_W , t_{PP} , t_{SE} , t_{BE} , and t_{CE} in AC Characteristics). When the program, erase or write status register instruction has completed, the BUSY bit will be cleared to a “0” state indicating the device is ready for further instructions.

6.2.2 Write Enable Latch (WEL)

Write Enable Latch (WEL) is a read only bit in the status register (SR1[1]) which is set to a 1 after executing a Write Enable Instruction. The WEL status bit is cleared to a 0 when the device is written disabled. A write disable state occurs upon power-up or after any of the following instructions: Write Disable, Page Program, Sector Erase, Block Erase, Chip Erase and Write Status Register.

6.2.3 Block Protect Bits (BP2, BP1, BP0)

The Block Protect Bits (BP2, BP1, BP0) are non-volatile read / write bits in the Status Register (SR1[4:2]) that provide Write Protection control and status. Block Protect bits can be set using the Write Status Registers Command (see t_W in Section 8.5). All, none or a portion of the memory array can be protected from Program and Erase commands (see Section 6.4.2, Block Protection Maps). The factory default setting for the Block Protection Bits is 0 (none of the array is protected.)

6.2.4 Top / Bottom Block Protect (TB)

The non-volatile Top / Bottom bit (TB SR1[5]) controls whether the Block Protect Bits (BP2, BP1, BP0) protect from the Top (TB=0) or the Bottom (TB=1) of the array as shown in Section 6.4.2, Block Protection Maps. The factory default setting is TB=0. The TB bit can be set with the Write Status Registers Command depending on the state of the SRP0, and WEL bits.

6.2.5 Sector / Block Protect (SEC)

The non-volatile Sector / Block Protect bit (SEC SR1[6]) controls if the Block Protect Bits (BP2, BP1, BP0)



protect either 4-kB Sectors (SEC=1) or 64-kB Blocks (SEC=0) of the array as shown in Section 6.4.2, Block Protection Maps. The default setting is SEC=0.

6.2.6 Complement Protect (CMP)

The Complement Protect bit (CMP SR2[6]) is a non-volatile read / write bit in the Status Register (SR2[6]). It is used in conjunction with SEC, TB, BP2, BP1 and BP0 bits to provide more flexibility for the array protection. Once CMP is set to 1, previous array protection set by SEC, TB, BP2, BP1 and BP0 will be reversed. For instance, when CMP=0, a top 4-kB sector can be protected while the rest of the array is not; when CMP=1, the top 4-kB sector will become unprotected while the rest of the array become read-only. Refer to Section 6.4.2, Block Protection Maps for details. The default setting is CMP=0.

6.2.7 The Status Register Protect (SRP0)

The Status Register Protect bits (SRP0) are non-volatile read / write bits in the Status Register (SR1[7]). The SRP bits control the method of write protection: software protection, hardware protection.

Table 6.4 Status Register Protect

SRP0	WP#	Status Register	Description
0	X	Software Protection	WP# pin has no control. SR1 and SR2 can be written to after a Write Enable command, WEL=1. [Factory Default]
1	0	Hardware Protected	When WP# pin is low the SR1 and SR2 are locked and cannot be written.
1	1	Hardware Unprotected	When WP# pin is high SR1 and SR2 are unlocked and can be written to after a Write Enable command, WEL=1.

Notes:

1. Busy, WEL, and SUS (SR1[1:0] and SR2[7]) are volatile read only status bits that are never affected by the Write Status Registers command.
2. The non-volatile version of HRSW, HFM, CMP, QE, SRP0, SEC, TB, and BP2-BP0 (SR3[7,4], SR2[6,1] and SR1[6:2]) bits and the OTP LB3-LB1 bits are not writable when protected by the SRP bits and WP# as shown in the table. The non-volatile version of these Status Register bits is selected for writing when the Write Enable (06h) command precedes the Write Status Registers (01h) command.
3. The volatile version of HRSW, DRV1, DRV0, HFM, CMP, QE, SRP0, SEC, TB, and BP2-BP0 (SR3[7:4], SR2[6,1] and SR1[6:2]) bits are not writable when protected by the SRP bits and WP# as shown in the table. The volatile version of these Status Register bits is selected for writing when the Write Enable for volatile Status Register (50h) command precedes the Write Status Registers (01h) command. There is no volatile version of the LB3-LB1 bits and these bits are not affected by a volatile Write Status Registers command.

6.2.8 Erase / Program Suspend Status (SUS)

The Suspend Status bit is a read only bit in the status register (SR2[7]) that is set to 1 after executing an Erase / Program Suspend (75h) command. The SUS status bit is cleared to 0 by Erase / Program Resume (7Ah) command as well as a power-down, power-up cycle.

6.2.9 Security Register Lock Bits (LB3, LB2, LB1)

The Security Register Lock Bits (LB3, LB2, LB1) are non-volatile One Time Program (OTP) bits in Status Register (SR2[5:2]) that provide the write protect control and status to the Security Registers. The default state of LB[3:1] is 0, Security Registers 1 to 3 are unlocked. LB[3:1] can be set to 1 individually using the Write Status Registers command. LB[3:1] are One Time Programmable (OTP), once it's set to 1, the corresponding 256-byte Security Register will become read-only permanently.

6.2.10 Quad Enable (QE)

The Quad Enable (QE) bit is a non-volatile read / write bit in the Status Register (SR2[1]) that allows Quad SPI operation. When the QE bit is set to a 0 state (factory default), the WP# pin and HOLD# / RESET# are enabled. When the QE bit is set to a 1, the Quad IO2 and IO3 pins are enabled, and WP# and HOLD# / RESET# functions are disabled.

Note: If the WP# or HOLD# / RESET# pins are tied directly to the power supply or ground during standard SPI or Dual SPI operation, the QE bit should never be set to a 1.



6.2.11 HOLD# or RESET# Pin Function (HRSW)

The HRSW bit is used to determine whether HOLD# or RESET# function should be implemented on the hardware pin for 8-pin packages. When HRSW=0, the pin acts as #HOLD; when HRSW=1, the pin acts as RESET#. However, HOLD# or RESET# functions are only available when QE=0. If QE is set to 1, the HOLD# and RESET# functions are disabled, the pin acts as a dedicated data I/O pin.

6.2.12 Output Driver Strength (DRV1, DRV0)

The DRV1 & DRV0 bits are used to determine the output driver strength for the Read operations.

DRV1, DRV0	Driver Strength
0, 0	50%
0, 1	25%
1, 0	75%
1, 1	100%

6.2.13 High Frequency Mode Enable Bit (HFM)

The HFM bit is used to determine whether the device is in High Frequency Mode. When HFM bit sets to 1, it means the device is in High Frequency Mode, when HFM bit sets 0 (default), it means the device is not in High Frequency Mode. This Mode allows pre-charge of internal charge pump, so the voltages required for accessing the flash memory array are readily available for read. After the HFM is executed, the device will maintain a slightly higher standby current (ICC8) than standard SPI operation.



6.3. Write Protection

Applications that use non-volatile memory must take into consideration the possibility of noise and other adverse system conditions that may compromise data integrity. To address this concern the ZB25VQ80A provides the following data protection mechanisms:

6.3.1 Write Protect Features

- ◆ Device resets when V_{CC} is below threshold
- ◆ Time delay write disable after Power-Up
- ◆ Write enable / disable commands and automatic write disable after erase or program
- ◆ Command length protection
 - All commands that Write, Program or Erase must complete on a byte boundary (CS# driven high after a full 8 bits have been clocked) otherwise the command will be ignored.
- ◆ Software and Hardware write protection using Status Register control
 - WP# input protection
 - Lock Down write protection until next power-up or Software Reset
 - One-Time Program (OTP) write protection
- ◆ Write Protection using the Deep Power-Down command

Upon power-up or at power-down, the ZB25VQ80A will maintain a reset condition while V_{CC} is below the threshold value of VWI, (see Figure 8.1). While reset, all operations are disabled and no commands are recognized. During power-up and after the V_{CC} voltage exceeds VWI, all program and erase related commands are further disabled for a time delay of tPUW. This includes the Write Enable, Page Program, Sector Erase, Block Erase, Chip Erase and the Write Status Registers commands. Note that the chip select pin (CS#) must track the V_{CC} supply level at power-up until the V_{CC} -min level and tVSL time delay is reached. If needed a pull-up resistor on CS# can be used to accomplish this.

After power-up the device is automatically placed in a write-disabled state with the Status Register Write Enable Latch (WEL) set to a 0. A Write Enable command must be issued before a Page Program, Sector Erase, Block Erase, Chip Erase or Write Status Registers command will be accepted. After completing a program, erase or write command the Write Enable Latch (WEL) is automatically cleared to a write-disabled state of 0.

Software controlled main flash array write protection is facilitated using the Write Status Registers command to write the Status Register (SR1,SR2) and Block Protect (SEC, TB, BP2, BP1 and BP0) bits.

The BP method allows a portion as small as 4-kB sector or the entire memory array to be configured as read only. Used in conjunction with the Write Protect (WP#) pin, changes to the Status Register can be enabled or disabled under hardware control. See the Table 6.4 for further information.

Additionally, the Deep Power-Down (DPD) command offers an alternative means of data protection as all commands are ignored during the DPD state, except for the Release from Deep-Power-Down (RES ABh) command. Thus, preventing any program or erase during the DPD state.



6.3.2 Block Protection Maps

Table 6.6 ZB25VQ80A Block Protection (CMP = 0)

Status Register ⁽¹⁾					ZB25VQ80A(8 Mbit) Block Protection (CMP=0) ⁽²⁾			
SEC	TB	BP2	BP1	BP0	Protected Block(s)	Protected Addresses	Protected Density	Protected Portion
X	X	0	0	0	None	None	None	None
0	0	0	0	1	15	0F0000h – 0FFFFFFh	64 kB	Upper 1/16
0	0	0	1	0	14 and 15	0E0000h – 0FFFFFFh	128 kB	Upper 1/8
0	0	0	1	1	12 thru 15	0C0000h – 0FFFFFFh	256 kB	Upper 1/4
0	0	1	0	0	8 thru 15	080000h – 0FFFFFFh	512 kB	Upper 1/2
0	1	0	0	1	0	000000h – 00FFFFh	64 kB	Lower 1/16
0	1	0	1	0	0 and 1	000000h – 01FFFFh	128 kB	Lower 1/8
0	1	0	1	1	0 thru 3	000000h – 03FFFFh	256 kB	Lower 1/4
0	1	1	0	0	0 thru 7	000000h – 07FFFFh	512 kB	Lower 1/2
0	X	1	0	1	0 thru 15	000000h – 0FFFFFFh	1 MB	All
X	X	1	1	X	0 thru 15	000000h – 0FFFFFFh	1 MB	All
1	0	0	0	1	15	0FF000h – 0FFFFFFh	4 kB	Upper 1/256
1	0	0	1	0	15	0FE000h – 0FFFFFFh	8 kB	Upper 1/128
1	0	0	1	1	15	0FC000h – 0FFFFFFh	16 kB	Upper 1/64
1	0	1	0	X	15	0F8000h – 0FFFFFFh	32 kB	Upper 1/32
1	1	0	0	1	0	000000h – 000FFFh	4 kB	Lower 1/256
1	1	0	1	0	0	000000h – 001FFFh	8 kB	Lower 1/128
1	1	0	1	1	0	000000h – 003FFFh	16 kB	Lower 1/64
1	1	1	0	X	0	000000h – 007FFFh	32 kB	Lower 1/32

Notes:

1. X = don't care.
2. If any Erase or Program command specifies a memory region that contains protected data portion, this command will be ignored.



Table 6.7 ZB25VQ80A Block Protection (CMP = 1)

Status Register ⁽¹⁾					ZB25VQ80A(8 Mbit) Block Protection (CMP=1) ⁽²⁾			
SEC	TB	BP2	BP1	BP0	Protected Block(s)	Protected Addresses	Protected Density	Protected Portion
X	X	0	0	0	0 thru 15	000000h – 0FFFFFFh	1 MB	All
0	0	0	0	1	0 thru 14	000000h – 0EFFFFh	960 kB	Lower 15/16
0	0	0	1	0	0 thru 13	000000h – 0DFFFFh	896 kB	Lower 7/8
0	0	0	1	1	0 thru 11	000000h – 0BFFFFh	768 kB	Lower 3/4
0	0	1	0	0	0 thru 7	000000h – 07FFFFh	512 kB	Lower 1/2
0	1	0	0	1	1 thru 15	010000h – 0FFFFFFh	960 kB	Upper 15/16
0	1	0	1	0	2 thru 15	020000h – 0FFFFFFh	896 kB	Upper 7/8
0	1	0	1	1	4 thru 15	040000h – 0FFFFFFh	768 kB	Upper 3/4
0	1	1	0	0	8 thru 15	080000h – 0FFFFFFh	512 kB	Upper 1/2
0	X	1	0	1	None	None	None	None
X	X	1	1	X	None	None	None	None
1	0	0	0	1	0 thru 15	000000h – 0EFFFFh	1020 kB	Lower 255/256
1	0	0	1	0	0 thru 15	000000h – 0DFFFFh	1016 kB	Lower 127/128
1	0	0	1	1	0 thru 15	000000h – 0BFFFFh	1008 kB	Lower 63/64
1	0	1	0	X	0 thru 15	000000h – 0F7FFFh	992 kB	Lower 31/32
1	1	0	0	1	0 thru 15	001000h – 0FFFFFFh	1020 kB	Upper 255/256
1	1	0	1	0	0 thru 15	002000h – 0FFFFFFh	1016 kB	Upper 127/128
1	1	0	1	1	0 thru 15	004000h – 0FFFFFFh	1008 kB	Upper 63/64
1	1	1	0	X	0 thru 15	008000h – 0FFFFFFh	992 kB	Upper 31/32

Notes:

1. X = don't care.
2. If any Erase or Program command specifies a memory region that contains protected data portion, this command will be ignored.



6.4. Page Program

To program one data byte, two instructions are required: Write Enable (WREN), which is one byte, and a Page Program (PP) sequence, which consists of four bytes plus data. This is followed by the internal Program cycle (of duration t_{PP}). To spread this overhead, the Page Program (PP) instruction allows up to 256 bytes to be programmed at a time (changing bits from 1 to 0), provided that they lie in consecutive addresses on the same page of memory.

6.5. Sector Erase, Block Erase and Chip Erase

The Page Program (PP) instruction allows bits to be reset from 1 to 0. Before this can be applied, the bytes of memory need to be erased to all 1s (FFh). This can be achieved a sector at a time, using the Sector Erase (SE) instruction, a block at a time using the Block Erase (BE) instruction or throughout the entire memory, using the Chip Erase (CE) instruction. This starts an internal Erase cycle (of duration t_{SE} , t_{BE} or t_{CE}). The Erase instruction must be preceded by a Write Enable (WREN) instruction.

6.6. Polling during a Write, Program or Erase Cycle

A further improvement in the time to Write Status Register (WRSR), Program (PP) or Erase (SE, BE or CE) can be achieved by not waiting for the worst case delay (t_W , t_{PP} , t_{SE} , t_{BE} or t_{CE}). The Write In Progress (WIP) bit is provided in the Status Register so that the application program can monitor its value, polling it to establish when the previous Write cycle, Program cycle or Erase cycle is complete.

6.7. Active Power, Stand-by Power and Deep Power-Down Modes

When Chip Select (CS#) is Low, the device is enabled, and in the Active Power mode. When Chip Select (CS#) is High, the device is disabled, but could remain in the Active Power mode until all internal cycles have completed (Program, Erase, Write Status Register). The device then goes into the Standby Power mode. The device consumption drops to ICC1.

The Deep Power-down mode is entered when the specific instruction (the Enter Deep Power-down Mode (DP) instruction) is executed. The device consumption drops further to ICC2. The device remains in this mode until another specific instruction (the Release from Deep Power-down Mode and Read Device ID (RDI) instruction) is executed.

All other instructions are ignored while the device is in the Deep Power-down mode. This can be used as an extra software protection mechanism, when the device is not in active use, to protect the device from inadvertent Program or Erase instructions.



7. INSTRUCTIONS

The instruction set of the ZB25VQ80A consists of forty basic instructions that are fully controlled through the SPI bus. Instructions are initiated with the falling edge of Chip Select (CS#). The first byte of data clocked into the DI input provides the instruction code. Data on the DI input is sampled on the rising edge of clock with most significant bit (MSB) first.

Instructions vary in length from a single byte to several bytes and may be followed by address bytes, data bytes, dummy bytes (don't care), and in some cases, a combination. Instructions are completed with the rising edge of edge CS#. Clock relative timing diagrams for each instruction are included in figures 7.1 through 7.43. All read instructions can be completed after any clocked bit. However, all instructions that Write, Program or Erase must complete on a byte boundary (CS driven high after a full 8-bits have been clocked) otherwise the instruction will be ignored. This feature further protects the device from inadvertent writes. Additionally, while the memory is being programmed or erased, or when the Status Register is being written, all instructions except for Read Status Register and Erase/Program Suspend will be ignored until the program or erase cycle completes.

Table 7.1 Command Set (Configuration, Status, Erase, Program Instructions⁽¹⁾, SPI Mode)

Command Name	BYTE 1 (Instruction)	BYTE 2	BYTE 3	BYTE 4	BYTE 5	BYTE 6
Read Status Register-1	05h	SR1[7:0] ⁽²⁾				
Read Status Register-2	35h	SR2[7:0] ⁽²⁾				
Read Status Register-3	15h/33h	SR3[7:0] ⁽²⁾				
Write Enable	06h					
Write Enable for Volatile Status Register	50h					
Write Disable	04h					
Write Status Registers-1	01h	SR1[7:0] ⁽⁵⁾	SR2[7:0]	SR3[7:0]		
Write Status Registers-2	31h	SR2[7:0]				
Write Status Registers-3	11h	SR3[7:0]				
Set Burst with Wrap	77h	xxh	xxh	xxh	W[7:0] ⁽³⁾	
Page Program	02h	A23—A16	A15—A8	A7—A0	D7—D0	
Quad Page Program	32h	A23—A16	A15—A8	A7—A0	D7—D0 ⁽⁴⁾	
Sector Erase (4 KB)	20h	A23—A16	A15—A8	A7—A0		
Block Erase (32 KB)	52h	A23—A16	A15—A8	A7—A0		
Block Erase (64 KB)	D8h	A23—A16	A15—A8	A7—A0		
Chip Erase	C7h/60h					
Erase/Program Suspend	75h					
Erase/Program Resume	7Ah					
Enable Reset	66h					
Reset Device	99h					

Notes:

- Data bytes are shifted with Most Significant Bit first. Byte fields with data in parenthesis “()” indicate data being read from the device on the DO pin.
- Status Register contents will repeat continuously until CS# terminates the command.
- Set Burst with Wrap Input format.
IO0 = x, x, x, x, x, x, W4, x]
IO1 = x, x, x, x, x, x, W5, x]
IO2 = x, x, x, x, x, x, W6 x]
IO3 = x, x, x, x, x, x, x, x
- Quad Page Program Input Data:
IO0 =(D4,D0,...)
IO1 = (D5,D1,...)
IO2 = (D6,D2,...)
IO3 =(D7,D3,...)
- The 01h command could continuously write up to three bytes to registers SR1, SR2, SR3.

Table 7.2 Command Set (Read Instructions ⁽¹⁾, SPI Mode)

Command Name	BYTE 1 (Instruction)	BYTE 2	BYTE 3	BYTE 4	BYTE 5	BYTE 6
Read Data	03h	A23—A16	A15—A8	A7—A0	(D7—D0,...)	
Fast Read	0Bh	A23—A16	A15—A8	A7—A0	dummy	(D7—D0,...)
Fast Read Dual Output	3Bh	A23—A16	A15—A8	A7—A0	dummy	(D7—D0,...) ⁽¹⁾
Fast Read Quad Output	6Bh	A23—A16	A15—A8	A7—A0	dummy	(D7—D0,...) ⁽³⁾
Fast Read Dual I/O	BBh	A23—A8 ⁽²⁾	A7—A0,M7—M0 ⁽²⁾	(D7—D0,...) ⁽¹⁾		
Fast Read Quad I/O	EBh	A23—A0,M7—M0 ⁽⁴⁾	(x,x,x,x,D7—D0,...)	(D7—D0,...) ⁽³⁾		
QUAD I/O WORD FAST READ ⁽⁵⁾	E7H	A23—A0,M7—M0 ⁽⁴⁾	(x,x,D7—D0,...)	(D7—D0,...) ⁽³⁾		
Octal Word Read Quad I/O ⁽⁵⁾	E3h	A23—A0,M7—M0 ⁽⁴⁾	(D7—D0,...) ⁽³⁾	(D7—D0,...) ⁽³⁾		

Notes:

- Dual Output data
IO0 = (D6, D4, D2, D0)
IO1 = (D7, D5, D3, D1)
- Dual Input Address
IO0 = A22, A20, A18, A16, A14, A12, A10, A8 A6, A4, A2, A0, M6, M4, M2, M0
IO1 = A23, A21, A19, A17, A15, A13, A11, A9 A7, A5, A3, A1, M7, M5, M3, M1
- Quad Output Data
IO0 = (D4, D0,)
IO1 = (D5, D1,)
IO2 = (D6, D2,)
IO3 = (D7, D3,)
- Quad Input Address
IO0 = A20, A16, A12, A8, A4, A0, M4, M0
IO1 = A21, A17, A13, A9, A5, A1, M5, M1
IO2 = A22, A18, A14, A10, A6, A2, M6, M2
IO3 = A23, A19, A15, A11, A7, A3, M7, M3
- For Word Read Quad I/O, the lowest address bit must be 0. (A0 = 0), and for Octal Word Read Quad I/O, the lowest four address bits must be 0. (A3, A2, A1, A0 = 0)



Table 7.3 Command Set (Read ID, OTP Instructions ⁽¹⁾, SPI Mode)

Command Name	BYTE 1 (Instruction)	BYTE 2	BYTE 3	BYTE 4	BYTE 5	BYTE 6
Deep Power-down	B9h					
Release Power down / Device ID	ABh	dummy	dummy	dummy	Device ID ⁽¹⁾	
Manufacturer/ Device ID ⁽²⁾	90h	dummy	dummy	00h	Manufacturer	Device ID
Manufacturer/ Device ID by Dual I/O	92h	A23—A8	A7—A0,M[7:0]	(MF[7:0],ID[7:0])		
Manufacturer/ Device ID by Quad I/O	94h	A23—A0,M[7:0]	XXXX,(MF[7:0],ID[7:0])	(MF[7:0],ID[7:0]...)		
JEDEC ID	9Fh	Manufacturer	Memory Type	Capacity		
Read SFDP Register	5Ah	00h	00h	A7—A0	dummy	(D7—D0,...)
Read Security Registers ⁽³⁾	48h	A23—A16	A15—A8	A7—A0	dummy	(D7—D0,...)
Erase Security Registers ⁽³⁾	44h	A23—A16	A15—A8	A7—A0		
Program Security Registers ⁽³⁾	42h	A23—A16	A15—A8	A7—A0	D7—D0,...	
Read Unique ID	4Bh	dummy	dummy	dummy	dummy	(ID63-ID0)

Notes:

1. The Device ID will repeat continuously until CS# terminates the command.
2. See Section 6.4.1, Legacy Device Identification Commands on page 51 for Device ID information. The 90h instruction is followed by an address. Address = 0 selects Manufacturer ID as the first returned data as shown in the table. Address = 1 selects Device ID as the first returned data followed by Manufacturer ID.
3. Security Register Address:
 Security Register 0: A23-16 = 00h; A15-8 = 00h; A7-0 = byte address
 Security Register 1: A23-16 = 00h; A15-8 = 10h; A7-0 = byte address
 Security Register 2: A23-16 = 00h; A15-8 = 20h; A7-0 = byte address
 Security Register 3: A23-16 = 00h; A15-8 = 30h; A7-0 = byte address

Table 7.4⁽¹⁾ Manufacturer and Device Identification(ZB25VQ80A)

OP Code	Data1	Data2	Data3
ABh	Device ID = 13h	-	-
90h/92h/94h	Manufacturer ID = 5E	Device ID = 13h	-
9Fh	Manufacturer ID = 5E	Memory Type =60h	Capacity = 14h

Notes:

- (1)Please contact sales for more information



7.1 Configuration and Status Commands

7.1.1 Read Status Register (05h/35h/15h)

The Read Status Register commands allow the 8-bit Status Registers to be read. The command is entered by driving CS# low and shifting the instruction code “05h” for Status Register-1, “35h” for Status Register-2, “15h” for Status Register-3 into the DI pin on the rising edge of CLK. The Status Register bits are then shifted out on the DO pin at the falling edge of CLK with most significant bit (MSB) first as shown in Figure 7.1. The Status Register bits are shown in Section 6.2, Status Registers.

The Read Status Register-1 (05h) command may be used at any time, even during a Program, Erase, or Write Status Registers cycle. This allows the BUSY status bit to be checked to determine when the operation is complete and if the device can accept another command.

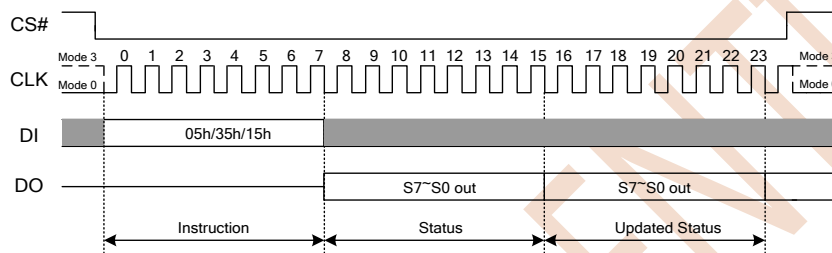

Figure 7.1 Read Status Register Instruction

7.1.2 Write Enable (06h)

The Write Enable instruction (Figure 7.2) sets the Write Enable Latch (WEL) bit in the Status Register to a 1. The WEL bit must be set prior to every Page Program, Sector Erase, Block Erase, Chip Erase and Write Status Register instruction. The Write Enable instruction is entered by driving CS# low, shifting the instruction code “06h” into the Data Input (DI) pin on the rising edge of CLK, and then driving CS# high.

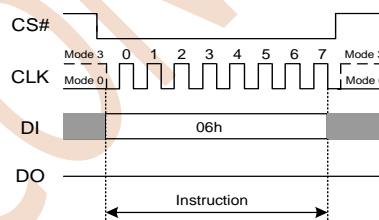

Figure 7.2 Write Enable Instruction

7.1.3 Write Enable for Volatile Status Register (50h)

The non-volatile Status Register bits described in section 6.2 can also be written to as volatile bits. This gives more flexibility to change the system configuration and memory protection schemes quickly without waiting for the typical non-volatile bit write cycles or affecting the endurance of the Status Register non-volatile bits. To write the volatile values into the Status Register bits, the Write Enable for Volatile Status Register (50h) instruction must be issued prior to a Write Status Register (01h) instruction. Write Enable for Volatile Status Register instruction (Figure 7.3) will not set the Write Enable Latch (WEL)bit, it is only valid for the Write Status Register instruction to change the volatile Status Register bit values.

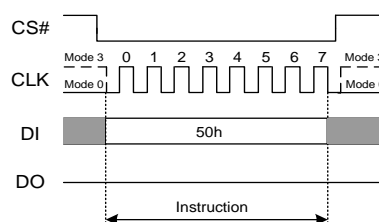



Figure 7.3 Write Enable for Volatile Status Register Instruction

7.1.4 Write Disable (04h)

The Write Disable instruction (Figure 7.4) resets the Write Enable Latch (WEL) bit in the Status Register to a 0. The Write Disable instruction is entered by driving CS# low, shifting the instruction code “04h” into the DI pin and then driving CS# high. Note that the WEL bit is automatically reset after Power-up and upon completion of the Write Status Register, Page Program, Sector Erase, Block Erase and Chip Erase instructions.

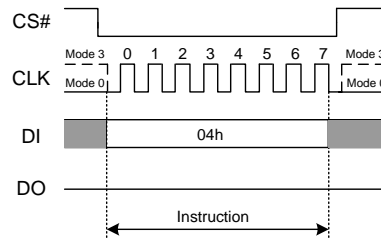

Figure 7.4 Write Disable Instruction

7.1.5 Write Status Register (01h/31h/11h)

The Write Status Registers command allows the Status Registers to be written. Only non-volatile Status Register bits SRP0, SEC, TB, BP2, BP1, BP0 (SR1[7:2]) CMP, LB3, LB2, LB1, QE, (SR2[6:1]), and the volatile bits SR3[6:0] can be written. All other Status Register bit locations are read-only and will not be affected by the Write Status Registers command. LB[3:0] are non-volatile OTP bits; once each is set to 1, it cannot be cleared to 0. The Status Register bits are shown in Section 6.2, Status Registers. Any reserved bits should only be written to their default value.

To write non-volatile Status Register bits, a standard Write Enable (06h) command must previously have been executed for the device to accept the Write Status Registers Command (Status Register bit WEL must equal 1). Once write enabled, the command is entered by driving CS# low, sending the instruction code “01h”, and then writing the Status Register data bytes as illustrated in Figure 7.5.

To write volatile Status Register bits, a Write Enable for Volatile Status Register (50h) command must have been executed prior to the Write Status Registers command (Status Register bit WEL remains 0). However, LB3, LB2, LB1 cannot be changed because of the OTP protection for these bits. Upon power-off, the volatile Status Register bit values will be lost, and the non-volatile Status Register bit values will be restored when power on again.

To complete the Write Status Registers command, the CS# pin must be driven high after the eighth bit of a data value is clocked in (CS# must be driven high on an 8-bit boundary). If this is not done the Write Status Registers command will not be executed.

The Write Status Register instruction allows the Status Register to be written. A Write Enable instruction must previously have been executed for the device to accept the Write Status Register Instruction (Status Register bit WEL must equal to 1). Once write enabled, the instruction is entered by driving CS# low, sending the instruction code “01h”, and then writing the status register data byte as illustrated in Figure 7.5.

During non-volatile Status Register write operation (06h combined with 01h/31h), after CS# is driven high, the self-timed Write Status Register cycle will commence for a time duration of t_w (See AC Characteristics). While the Write Status Register cycle is in progress, the Read Status Register instruction may still be accessed to check the status of the BUSY bit. The BUSY bit is a 1 during the Write Status Register cycle and a 0 when the cycle is finished and ready to accept other instructions again. After the Write Status Register cycle has finished, the Write Enable Latch (WEL) bit in the Status Register will be cleared to 0.

During volatile Status Register write operation (50h combined with 01h/31h/11h), after CS# is driven high, the Status Register bits will be refreshed to the new values within the time period of t_{SHSL2} (See AC Characteristics). BUSY bit will remain 0 during the Status Register bit refresh period.



If CS# is driven high after the eighth clock, the Write Status Register-1 (01h) instruction will only program the Status Register-1, the Status Register-2 will not be affected.

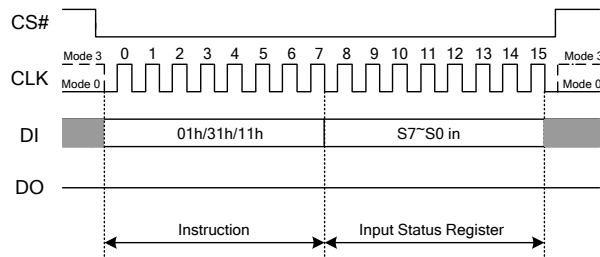

Figure 7.5 Write Status Register Instruction

7.2 Program and Erase Commands

7.2.1 Page Program (PP) (02h)

The Page Program instruction allows up to 256 bytes of data to be programmed at previously erased to all 1s (FFh) memory locations. A Write Enable instruction must be executed before the device will accept the Page Program Instruction (Status Register bit WEL must equal 1). The instruction is initiated by driving the CS# pin low then shifting the instruction code “02h” followed by a 24-bit address (A23-A0) and at least one data byte, into the DI pin. The CS# pin must be held low for the entire length of the instruction while data is being sent to the device. The Page Program instruction sequence is shown in Figure 7.6.

If an entire 256 byte page is to be programmed, the last address byte (the 8 least significant address bits) should be set to 0. If the last address byte is not zero, and the number of clocks exceeds the remaining page length, the addressing will wrap to the beginning of the page. In some cases, less than 256 bytes (a partial page) can be programmed without having any effect on other bytes within the same page. One condition to perform a partial page program is that the number of clocks cannot exceed the remaining page length. If more than 256 bytes are sent to the device the addressing will wrap to the beginning of the page and overwrite previously sent data.

As with the write and erase instructions, the CS# pin must be driven high after the eighth bit of the last byte has been latched. If this is not done the Page Program instruction will not be executed. After CS# is driven high, the self-timed Page Program instruction will commence for a time duration of t_{pp} (See AC Characteristics). While the Page Program cycle is in progress, the Read Status Register instruction may still be accessed for checking the status of the BUSY bit. The BUSY bit is a 1 during the Page Program cycle and becomes a 0 when the cycle is finished and the device is ready to accept other instructions again. After the Page Program cycle has finished the Write Enable Latch (WEL) bit in the Status Register is cleared to 0. The Page Program instruction will not be executed if the addressed page is protected by the Block Protect (TB, SEC, BP2, BP1, and BP0) bits (see Status Register Memory Protection table).

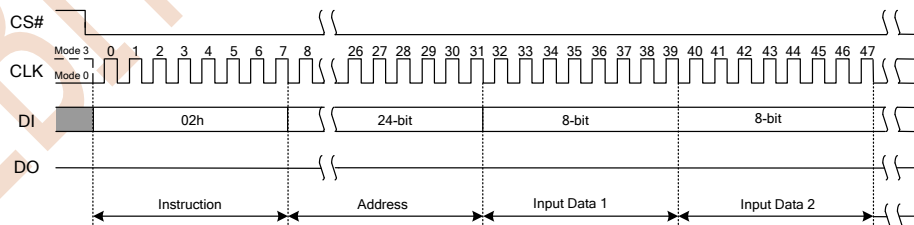

Figure 7.6a Page Program Instruction

7.2.2 Quad Input Page Program (32h)

The Quad Input Page Program instruction allows up to 256 byte of data to be programmed at previously erased (FFh) memory locations using four pins: IO0, IO1, IO2 and IO3. The Quad Input Page Program can improved performance for PROM Programmer and applications that have slow clock speeds < 5MHz. Systems with faster clock speed will not realize much benefit for the Quad Input Page Program instruction since the inherent page program time is much greater than the time it take to clock-in the data.



To use Quad Page Program the Quad Enable in Status Register-2 must be set (QE=1). A Write Enable instruction must be executed before the device will accept the Quad Page Program instruction (Status Register-1, WEL=1). The instruction is initiated by driving the CS# pin low then shifting the instruction code "32h" followed by a 24-bit address (A23-0) and at least one data byte, into the IO pins. The CS# pin must be held low for entire length of the instruction while data is being sent to the device. All other functions of Quad Page Program are identical to standard Page Program. The Quad Page Program instructions sequence is shown in Figure 7.7.

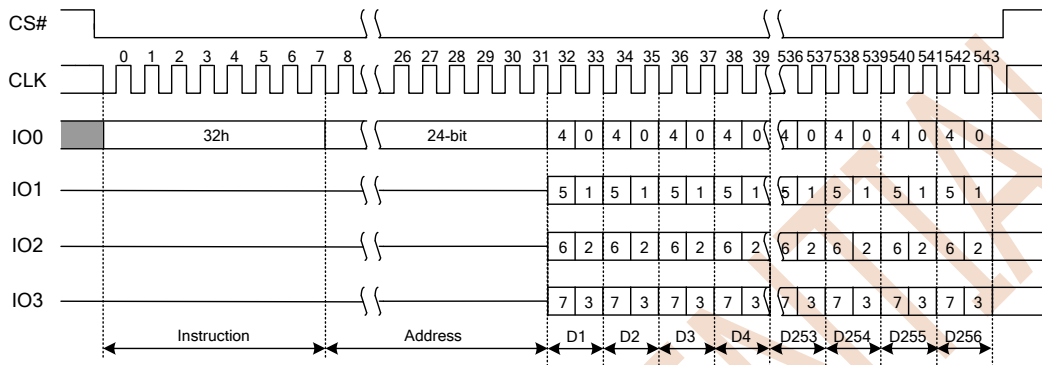

Figure 7.7 Quad Page Program Instruction

7.2.3 Sector Erase (SE) (20h)

The Sector Erase instruction sets all memory within a specified sector (4K-bytes) to the erased state of all 1s (FFh). A Write Enable instruction must be executed before the device will accept the Sector Erase Instruction (Status Register bit WEL must equal 1). The instruction is initiated by driving the CS# pin low and shifting the instruction code "20h" followed a 24-bit sector address (A23-A0). The Sector Erase instruction sequence is shown in Figure 7.8.

The CS# pin must be driven high after the eighth bit of the last byte has been latched. If this is not done the Sector Erase instruction will not be executed. After CS# is driven high, the self-timed Sector Erase instruction will commence for a time duration of t_{SE} (See AC Characteristics). While the Sector Erase cycle is in progress, the Read Status Register instruction may still be accessed for checking the status of the BUSY bit. The BUSY bit is a 1 during the Sector Erase cycle and becomes a 0 when the cycle is finished and the device is ready to accept other instructions again. After the Sector Erase cycle has finished the Write Enable Latch (WEL) bit in the Status Register is cleared to 0. The Sector Erase instruction will not be executed if the addressed page is protected by the Block Protect (TB, SEC, BP2, BP1, and BP0) bits (see Status Register Memory Protection table).

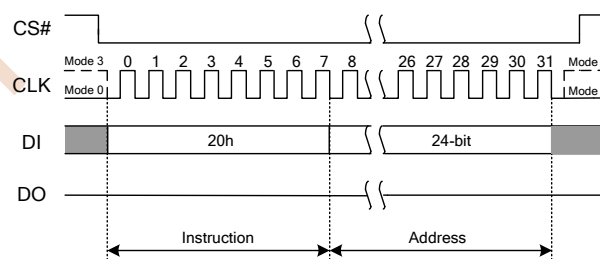

Figure 7.8 Sector Erase Instruction

7.2.4 Block Erase (BE) (D8h) and Half Block Erase (52h)

The Block Erase instruction sets all memory within a specified block (64K-bytes) or half block (32K-bytes) to the erased state of all 1s (FFh). A Write Enable instruction must be executed before the device will accept the Block Erase Instruction (Status Register bit WEL must equal 1). The instruction is initiated by driving the CS# pin low and shifting the instruction code "D8h" or "52h" followed a 24-bit block address (A23-A0). The Block Erase instruction sequence is shown in Figure 7.9.

The CS# pin must be driven high after the eighth bit of the last byte has been latched. If this is not done the Block Erase instruction will not be executed. After CS# is driven high, the self-timed Block Erase instruction will commence for a time duration of t_{BE} (See AC Characteristics). While the Block Erase cycle is in progress, the Read Status Register instruction may still be accessed for checking the status of the BUSY bit. The BUSY bit is a 1 during the Block Erase cycle and becomes a 0 when the cycle is finished and the device is ready to accept other instructions again. After the Block Erase cycle has finished the Write Enable Latch (WEL) bit in the Status Register is cleared to 0. The Block Erase instruction will not be executed if the addressed page is protected by the Block Protect (TB, SEC, BP2, BP1, and BP0) bits (see Status Register Memory Protection table).

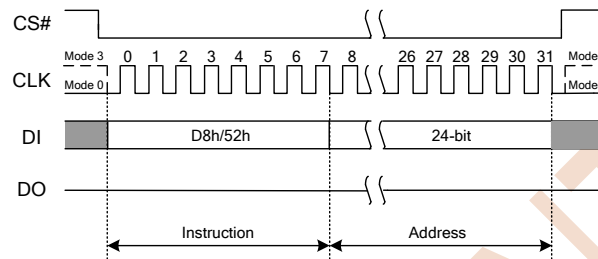

Figure 7.9a Block Erase Instruction

7.2.5 Chip Erase (CE) (C7h or 60h)

The Chip Erase instruction sets all memory within the device to the erased state of all 1s (FFh). A Write Enable instruction must be executed before the device will accept the Chip Erase Instruction (Status Register bit WEL must equal 1). The instruction is initiated by driving the CS# pin low and shifting the instruction code “C7h” or “60h”. The Chip Erase instruction sequence is shown in Figure 7.10.

The CS# pin must be driven high after the eighth bit has been latched. If this is not done the Chip Erase instruction will not be executed. After CS# is driven high, the self-timed Chip Erase instruction will commence for a time duration of t_{CE} (See AC Characteristics). While the Chip Erase cycle is in progress, the Read Status Register instruction may still be accessed to check the status of the BUSY bit. The BUSY bit is a 1 during the Chip Erase cycle and becomes a 0 when finished and the device is ready to accept other instructions again. After the Chip Erase cycle has finished the Write Enable Latch (WEL) bit in the Status Register is cleared to 0. The Chip Erase instruction will not be executed if any page is protected by the Block Protect (SEC, TB, BP2, BP1, and BP0) bits (see Status Register Memory Protection table).

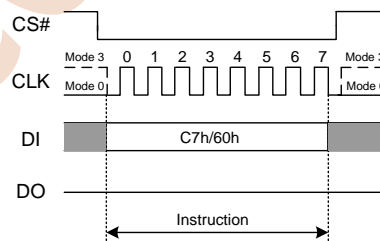

Figure 7.10 Chip Erase Instruction

7.2.6 Erase / Program Suspend (75h)

The Erase / Program Suspend command allows the system to interrupt a Sector or Block Erase operation, then read from or program data to any other sector. The Erase / Program Suspend command also allows the system to interrupt a Page Program operation and then read from any other page or erase any other sector or block. The Erase / Program Suspend command sequence is shown in Figure 7.11.

The Write Status Registers command (01h, 31h), and Erase commands (20h, 52h, D8h, C7h, 60h, 44h) are not allowed during Erase Suspend. Erase Suspend is valid only during the Sector or Block erase operation. If written during the Chip Erase operation, the Erase Suspend command is ignored. The Write Status Registers command (01h, 31h), and Program commands (02h, 32h, 42h) are not allowed during Program Suspend. Program Suspend is valid during the Page Program or Quad Page Program operation.



The Erase / Program Suspend command 75h will be accepted by the device only if the SUS bit in the Status Register equals to 0 and the BUSY bit equals to 1 while a Sector or Block Erase or a Page Program operation is on-going. If the SUS bit equals to 1 or the BUSY bit equals to 0, the Suspend command will be ignored by the device. Program or Erase command for the sector that is being suspended will be ignored.

A maximum of time of t_{SUS} (Section 8.5, AC Electrical Characteristics) is required to suspend the erase or program operation. The BUSY bit in the Status Register will be cleared from 1 to 0 within t_{SUS} and the SUS bit in the Status Register will be set from 0 to 1 immediately after Erase/Program Suspend. For a previously resumed Erase/Program operation, it is also required that the Suspend command 75h is not issued earlier than a minimum of time of t_{SUS} following the preceding Resume command 7Ah.

Unexpected power off during the Erase / Program suspend state will reset the device and release the suspend state. SUS bit in the Status Register will also reset to 0. The data within the page, sector or block that was being suspended may become corrupted. It is recommended for the user to implement system design techniques to prevent accidental power interruption, provide non-volatile tracking of in process program or erase commands, and preserve data integrity by evaluating the non-volatile program or erase tracking information during each system power up in order to identify and repair (re-erase and re-program) any improperly terminated program or erase operations.

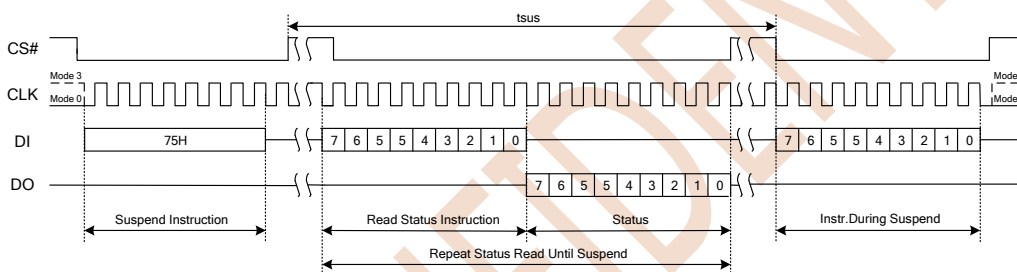

Figure 7.11 Erase / Program Suspend Instruction

7.2.7 Erase / Program Resume (7Ah)

The Erase / Program Resume command “7Ah” must be written to resume the Sector or Block Erase operation or the Page Program operation after an Erase / Program Suspend. The Resume command “7Ah” will be accepted by the device only if the SUS bit in the Status Register equals to 1 and the BUSY bit equals to 0. After the Resume command is issued the SUS bit will be cleared from 1 to 0 immediately, the BUSY bit will be set from 0 to 1 within 200 ns and the Sector or Block will complete the erase operation or the page will complete the program operation. If the SUS bit equals to 0 or the BUSY bit equals to 1, the Resume command “7Ah” will be ignored by the device. The Erase / Program Resume command sequence is shown in Figure 7.12. It is required that a subsequent Erase / Program Suspend command not to be issued within a minimum of time of “ t_{SUS} ” following a Resume command.

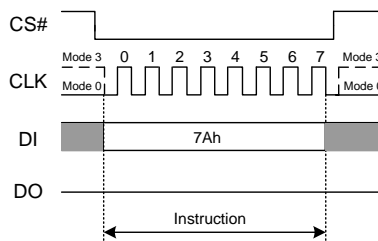

Figure 7.12 Erase/Program Resume Instruction

7.3 Read Commands

7.3.1 Read Data (03h)

The Read Data instruction allows one more data bytes to be sequentially read from the memory. The instruction is initiated by driving the CS# pin low and then shifting the instruction code “03h” followed by a 24-bit address (A23-A0) into the DI pin. The code and address bits are latched on the rising edge of the CLK



pin. After the address is received, the data byte of the addressed memory location will be shifted out on the DO pin at the falling edge of CLK with most significant bit (MSB) first. The address is automatically incremented to the next higher address after each byte of data is shifted out allowing for a continuous stream of data. This means that the entire memory can be accessed with a single instruction as long as the clock continues. The instruction is completed by driving CS# high.

The Read Data instruction sequence is shown in Figure 7.13. If a Read Data instruction is issued while an Erase, Program or Write cycle is in process (BUSY=1) the instruction is ignored and will not have any effects on the current cycle. The Read Data instruction allows clock rates from D.C. to a maximum of f_R (see AC Electrical Characteristics).

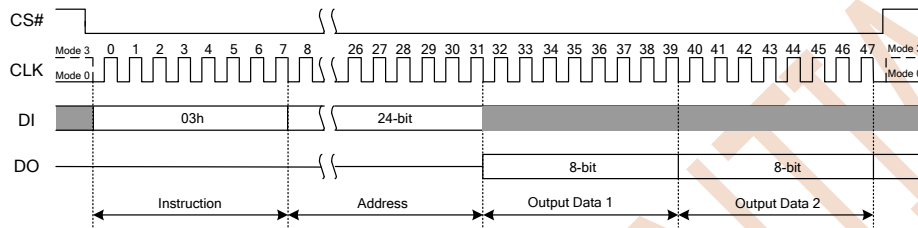

Figure 7.13 Read Data Instruction

7.3.2 Fast Read (0Bh)

The Fast Read instruction is similar to the Read Data instruction except that it can operate at the highest possible frequency of F_R (see AC Electrical Characteristics). This is accomplished by adding eight “dummy” clocks after the 24-bit address as shown in Figure 7.14. The dummy clocks allow the devices internal circuits additional time for setting up the initial address. During the dummy clocks the data value on the DI pin is a “don’t care”.

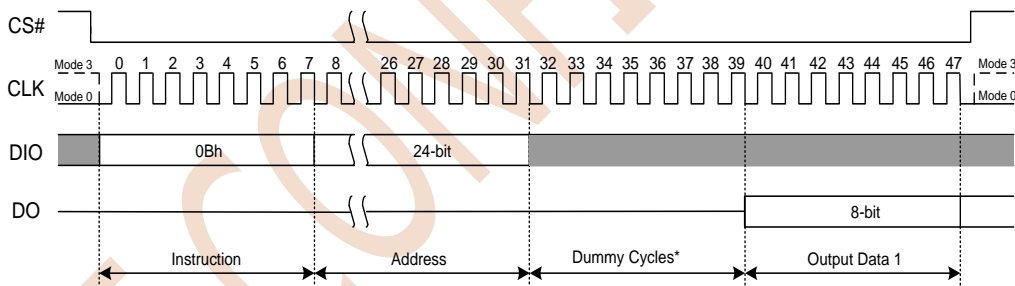

Figure 7.14a Fast Read Instruction

7.3.3 Fast Read Dual Output (3Bh)

The Fast Read Dual Output (3Bh) instruction is similar to the standard Fast Read (0Bh) instruction except that data is output on two pins, DO and DI, instead of just DO. This allows data to be transferred from the ZB25VQ80A at twice the rate of standard SPI devices. The Fast Read Dual Output instruction is ideal for quickly downloading code from Flash to RAM upon power-up or for applications that cache code-segments to RAM for execution.

Similar to the Fast Read instruction, the Fast Read Dual Output instruction can operate at the highest possible frequency of F_R (see AC Electrical Characteristics). This is accomplished by adding eight “dummy” clocks after the 24-bit address as shown in Figure 7.15. The dummy clocks allow the device’s internal circuits additional time for setting up the initial address. The input data during the dummy clocks is “don’t care”. However, the DI pin should be high-impedance prior to the falling edge of the first data out clock.

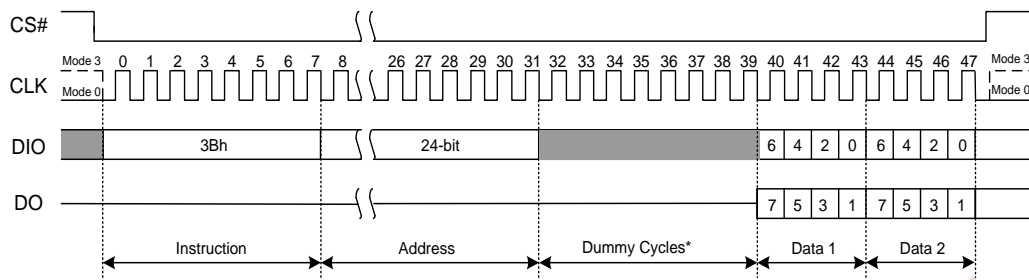

Figure 7.15 Fast Read Dual Output Instruction Sequence Diagram

7.3.4 Fast Read Quad Output (6Bh)

The Fast Read Quad Output (6Bh) instruction is similar to the Fast Dual Output (3Bh) instruction except that data is output on four pins, IO0, IO1, IO2 and IO3. A Quad enable of status Register-2 must be executed before the device will accept the Fast Read Quad Output Instruction (Status Register bit QE must equal 1). The Fast Read Quad Output Instruction allows data to be transferred from ZB25VQ80A at four times the rate of standard SPI devices.

The Fast Read Quad Output instruction can operate at the highest possible frequency of F_R (see AC Electrical Characteristics). This is accomplished by adding "dummy" clocks after the 24-bit address as shown in Figure 7.16. The input data during the dummy clocks is "don't care". However, the IO pins should be high-impedance prior to the falling edge of the first data out clock.

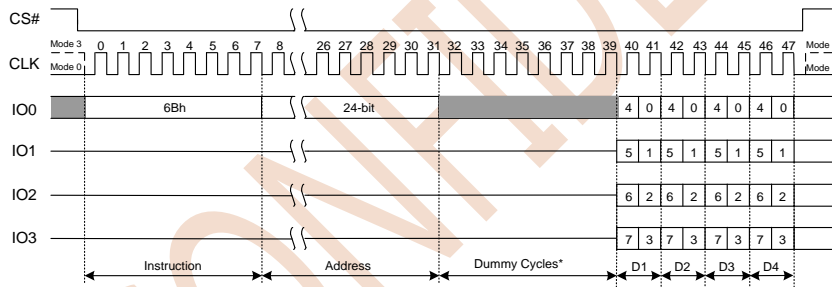

Figure 7.16 Fast Read Quad Output Instruction

7.3.5 Fast Read Dual I/O (BBh)

The Fast Read Dual I/O (BBh) instruction allows for improved random access while maintaining two IO pins, IO0 and IO1. It is similar to the Fast Read Dual Output (3Bh) instruction but with the capability to input the Address bits (A23-0) two bits per dock. This reduced instruction overhead may allow for code execution (XIP) directly from the Dual SPI in some applications.

Fast Read Dual I/O with "Continuous Read Mode"

The Fast Read Dual I/O instruction can further reduce instruction overhead through setting the "Continuous Read Mode" bits (M7-0) after the input Address bits (A23-0), as shown in Figure 7.17. The upper nibble of the (M7-4) controls the length of the next Fast Read Dual I/O instruction through the inclusion or exclusion of the first byte instruction code. The lower nibble bits of the (M3-0) are don't care ("X"). However, the IO pins should be high-impedance prior to the falling edge of the first data out clock. It is recommended to input FFFFh on IO0 for the next instruction (16 clocks), to ensure M4 = 1 and return the device to normal operation.

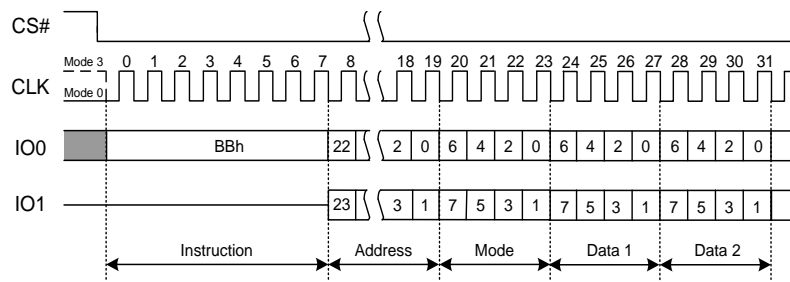

Figure 7.17 Fast Read Dual I/O Instruction (Initial command or previous M5-4≠10)

Note:

1. Least significant 4 bits of Mode are don't care and it is optional for the host to drive these bits. The host may turn off drive during these cycles to increase bus turnaround time between Mode bits from host and returning data from the memory

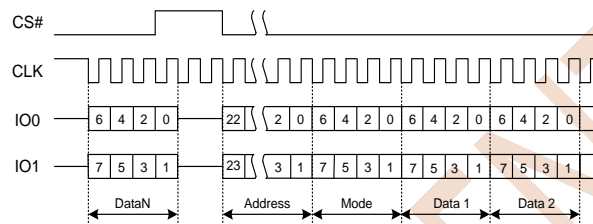

Figure 7.18 Fast Read Dual I/O Instruction (Initial command or previous M5-4=10)

7.3.6 Fast Read Quad I/O (EBh)

The Fast Read Quad I/O (EBh) command is similar to the Fast Read Dual I/O (BBh) command except that address and data bits are input and output through four pins IO0, IO1, IO2 and IO3 and Dummy clock are required prior to the data output. The Quad I/O dramatically reduces instruction overhead allowing faster random access for code execution (XIP) directly from the Quad SPI. The Quad Enable bit (QE) of Status Register-2 must be set to enable the Fast Read Quad I/O Command.

Fast Read Quad I/O with “Continuous Read Mode”

The Fast Read Quad I/O command can further reduce instruction overhead through setting the “Continuous Read Mode” bits (M7-0) after the input Address bits (A23-0), as shown in Figure 7.19, Fast Read Quad I/O Command Sequence (Initial command or previous M5-4≠10). The upper nibble of the (M7-4) controls the length of the next Fast Read Quad I/O command through the inclusion or exclusion of the first byte instruction code. The lower nibble bits of the (M3-0) are don't care (“X”). However, the IO pins should be high-impedance prior to the falling edge of the first data out clock.

If the “Continuous Read Mode” bits M5-4 = (1,0), then the next Fast Read Quad I/O command (after CS# is raised and then lowered) does not require the EBh instruction code, as shown in Figure 7.20, Fast Read Quad I/O Command Sequence (Previous command set M5-4 = 10). This reduces the command sequence by eight clocks and allows the Read address to be immediately entered after CS# is asserted low. If the “Continuous Read Mode” bits M5-4 do not equal to (1, 0), the next command (after CS# is raised and then lowered) requires the first byte instruction code, thus returning to normal operation. It is recommended to input FFh on IO0 for the next instruction (8 clocks), to ensure M4=1 and return the device to normal operation.

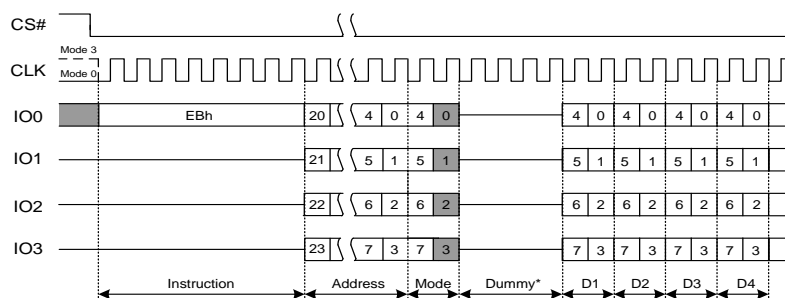



Figure 7.19a Fast Read Quad I/O Instruction(Initial command or previous M5-4 ≠10)

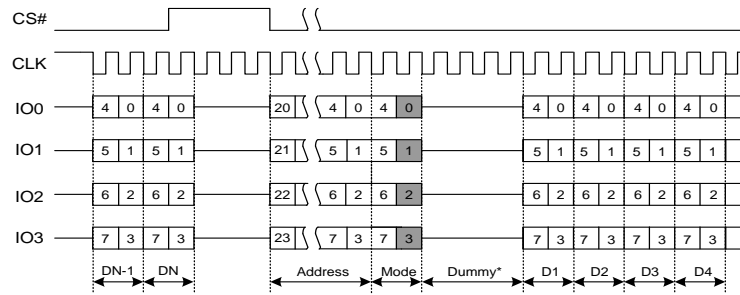

Figure 7.20 Fast Read Quad I/O Instruction(Previous command set M5-4 = 10)

Fast Read Quad I/O with “8/16/32/64-Byte Wrap Around”

The Fast Read Quad I/O command can also be used to access a specific portion within a page by issuing a “Set Burst with Wrap” command prior to EBh. The “Set Burst with Wrap” command can either enable or disable the “Wrap Around” feature for the following EBh commands. When “Wrap Around” is enabled, the data being accessed can be limited to 8/16/32/64-byte section of data. The output data starts at the initial address specified in the command, once it reaches the ending boundary of the 8/16/32/64-byte section, the output will wrap around to the beginning boundary automatically until CS# is pulled high to terminate the command.

The Burst with Wrap feature allows applications that use cache to quickly fetch a critical address and then fill the cache afterwards within a fixed length (8/16/32/64-bytes) of data without issuing multiple read commands.

The “Set Burst with Wrap” command allows three “Wrap Bits”, W6-4 to be set. The W4 bit is used to enable or disable the “Wrap Around” operation while W6-5 is used to specify the length of the wrap around section within a page. See Section 7.3.9, Set Burst with Wrap (77h).

7.3.7 Word Read Quad I/O (E7h)

The Word Read Quad I/O (E7h) instruction is similar to the Fast Quad I/O (EBh) instruction except that the lowest Address bit (A0) must equal to 0 and only two Dummy clocks are required prior to the data output. The Quad I/O dramatically reduces instruction overhead allowing faster random access for code execution (XIP) directly from the Quad SPI. The Quad Enable bit (QE) of Status Register-2 must be set to enable the Word Read Quad I/O instruction.

Word Read Quad I/O with "Continuous Read Mode"

The Word Read Quad I/O instruction can further reduce instruction overhead through setting the "Continuous Read Mode" bits (M7-0) after the input Address bits (A23-0), as shown in Figure 7.21. The upper nibble of the (M7-4) controls the length of the next Fast Read Quad I/O instruction through the inclusion or exclusion of the first byte instruction code. The lower nibble bits of the (M3-0) are don't care ("X"). However, the IO pins should be high-impedance prior to the falling edge of the first data out clock.

If the "Continuous Read Mode" bits M5-4 = (1,0), then the next Fast Read Quad I/O instruction (after CS# is raised and then lowered) does not require the E7h instruction code, as shown in Figure 7.22. This reduces the instruction sequence by eight clocks and allows the read address to be immediately entered after CS# is asserted low. The "Continuous Read Mode Reset" instruction is also able to reset M7-0 before issuing normal instructions.

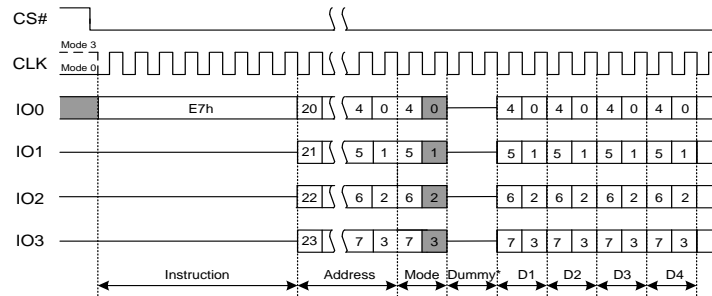

Figure 7.21 Word Read Quad I/O Instruction(Initial command or previous M5-4 ≠10)

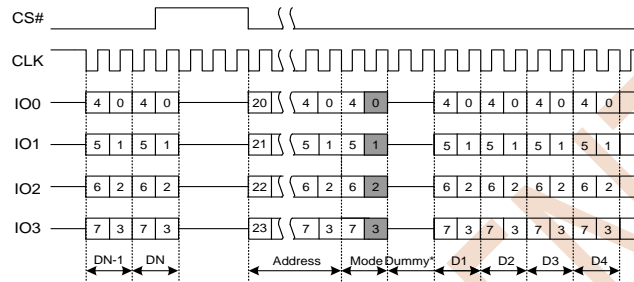

Figure 7.22 Word Read Quad I/O Instruction(Initial command or previous M5-4 =10)

Word Read Quad I/O with “8/16/32/64-Byte Wrap Around” in Standard SPI mode

The Word Read Quad I/O instruction can also be used to access a specific portion within a page by issuing a “Set Burst with Wrap” (77h) command prior to E7h. The “Set Burst with Wrap” (77h) command can either enable or disable the “Wrap Around” feature for the following E7h commands. When “Wrap Around” is enabled, the data being accessed can be limited to either an 8, 16, 32 or 64-byte section of a 256-byte page. The output data starts at the initial address specified in the instruction, once it reaches the ending boundary of the 8/16/32/64-byte section, the output will wrap around to the beginning boundary automatically until CS# is pulled high to terminate the command.

The Burst with Wrap feature allows applications that use cache to quickly fetch a critical address and then fill the cache afterwards within a fixed length (8/16/32/64-byte) of data without issuing multiple read commands.

The “Set Burst with Wrap” instruction allows three “Wrap Bits”, W6-4 to be set. The W4 bit is used to enable or disable the “Wrap Around” operation while W6-5 are used to specify the length of the wrap around section within a page. See 7.3.9 for detail descriptions.

7.3.8 Octal Word Read Quad I/O (E3h)

The Octal Word Read Quad I/O (E3h) instruction is similar to the Fast Read Quad I/O (EBh) instruction except that the lower four Address bits (A0, A1, A2, A3) must equal 0. As a result, the dummy clocks are not required, which further reduces the instruction overhead allowing even faster random access for code execution (XIP). The Quad Enable bit (QE) of Status Register-2 must be set to enable the Octal Word Read Quad I/O Instruction.

Octal Word Read Quad I/O with “Continuous Read Mode”

The Octal Word Read Quad I/O instruction can further reduce instruction overhead through setting the “Continuous Read Mode” bits (M7-0) after the input Address bits (A23-0), as shown in Figure 7.23. The upper nibble of the (M7-4) controls the length of the next Octal Word Read Quad I/O instruction through the inclusion or exclusion of the first byte instruction code. The lower nibble bits of the (M3-0) are don’t care (“x”). However, the IO pins should be high-impedance prior to the falling edge of the first data out clock.

If the “Continuous Read Mode” bits M5-4 = (1,0), then the next Fast Read Quad I/O instruction (after CS# is raised and then lowered) does not require the E3h instruction code, as shown in Figure 7.24. This reduces the



instruction sequence by eight clocks and allows the Read address to be immediately entered after CS# is asserted low. If the “Continuous Read Mode” bits M5-4 do not equal to (1,0), the next instruction (after CS# is raised and then lowered) requires the first byte instruction code, thus returning to normal operation. It is recommended to input FFh on IO0 for the next instruction (8 clocks), to ensure M4= 1 and return the device to normal operation.

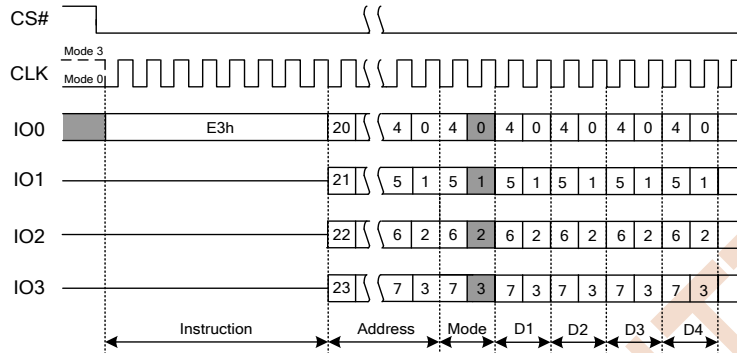

Figure 7.23 Octal Word Read Quad I/O Instruction(Initial command or previous M5-4 ≠10)

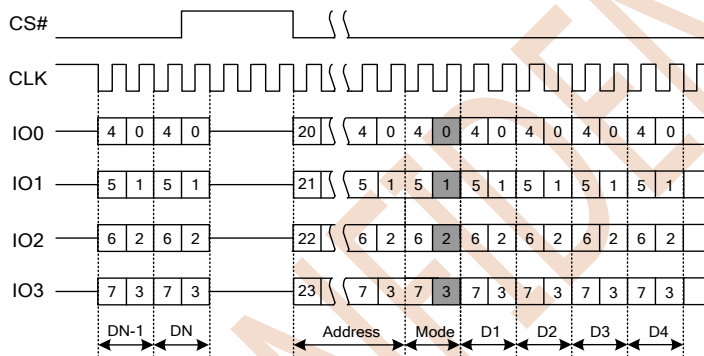

Figure 7.24 Octal Word Read Quad I/O Instruction(Initial command or previous M5-4 =10)

7.3.9 Set Burst with Wrap (77h)

The Set Burst with Wrap (77h) command is used in conjunction with “Fast Read Quad I/O” commands to access a fixed length and alignment of 8/16/32/64-bytes of data. Certain applications can benefit from this feature and improve the overall system code execution performance. This command loads the W4,W5,W6 bits. Similar to a Quad I/O command, the Set Burst with Wrap command is initiated by driving the CS# pin low and then shifting the instruction code “77h” followed by 24-dummy bits and 8 “Wrap Bits”, W7-0. The command sequence is shown in Figure 7.25, Set Burst with Wrap Command Sequence. Wrap bit W7 and the lower nibble W3-0 are not used.

W6, W5	W4=0		W4=1(DEFAULT)	
	Wrap Around	Wrap Length	Wrap Around	Wrap Length
0,0	Yes	8-byte	No	N/A
0,1	Yes	16-byte	No	N/A
1,0	Yes	32-byte	No	N/A
1,1	Yes	64-byte	No	N/A

Once W6-4 is set by a Set Burst with Wrap command, all the following “Fast Read Quad I/O” commands will use the W6-4 setting to access the 8/16/32/64-byte section of data. Note, Status Register-2 QE bit (SR2[1]) must be set to 1 in order to use the Fast Read Quad I/O and Set Burst with Wrap commands. To exit the “Wrap Around” function and return to normal read operation, another Set Burst with Wrap command should be issued to set W4 = 1. The default value of W4 upon power on is 1.

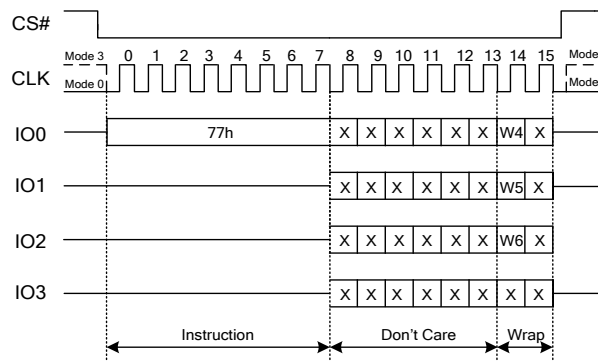
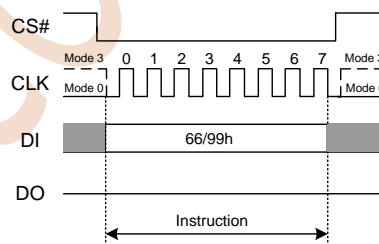

Figure 7.25 Set Burst with Wrap Instruction

7.4 Reset Commands

Software controlled Reset commands restore the device to its initial power up state, by reloading volatile registers from non-volatile default values. If a software reset is initiated during a Erase, Program or Writing Register operation the data in that Sector, Page or Register is not stable, the operation that was interrupted needs to be initiated again. Once the Reset instruction is accepted, any on-going internal operations will be terminated and the device will return to its default power-on state and lose all the current volatile settings, such as Volatile Status Register bits, Write Enable Latch (WEL) status, Program/Erase Suspend status, Read parameter setting (P7-P0), Continuous Read Mode bit setting (M7-M0) and Wrap Bit setting (W6-W4).

When the device is in Deep Power-Down mode, the software reset command is ignored and has no effect. To reset the device send the Release Power down command (ABh) and after time duration of t_{RES1} the device will resume normal operation and the software reset command will be accepted.

A software reset is initiated by the Software Reset Enable command (66h) followed by Software Reset command (99h) and then executed when CS# is brought high after t_{RCH} time at the end of the Software Reset instruction and requires t_{RST} time before executing the next Instruction after the Software Reset. See Figure 8.7, Software Reset Input Timing. Note that CS# must be brought high after t_{RCH} time, or the Software Reset will not be executed.

Figure 7.26 Software Reset Instruction

7.4.1 Software Reset Enable (66h)

The Reset Enable (66h) command is required immediately before a software reset command (99h) such that a software reset is a sequence of the two commands. Any command other than Reset (99h) following the Reset Enable (66h) command, will clear the reset enable condition and prevent a later Reset (99h) command from being recognized.

7.4.2 Software Reset (99h)

The Reset (99h) command immediately following a Reset Enable (66h) command, initiates the software reset process. Any command other than Reset (99h) following the Reset Enable (66h) command, will clear the reset enable condition and prevent a later Reset (99h) command from being recognized.

7.5 ID and Security Commands

7.5.1 Deep Power-down (DP) (B9h)

Although the standby current during normal operation is relatively low, standby current can be further reduced with the Power-down instruction. The lower power consumption makes the Power-down instruction especially useful for battery powered applications (See ICC1 and ICC2 in AC Characteristics). The instruction is initiated by driving the CS# pin low and shifting the instruction code “B9h” as shown in Figure 7.27.

The CS# pin must be driven high after the eighth bit has been latched. If this is not done, the Power-down instruction will not be executed. After CS# is driven high, the power-down state will enter within the time duration of t_{DP} (See AC Characteristics). While in the power-down state only the Release from Power-down / Device ID instruction, which restores the device to normal operation, will be recognized. All other instructions are ignored. This includes the Read Status Register instruction, which is always available during normal operation. Ignoring all but one instruction makes the Power Down state a useful condition for securing maximum write protection. The device always powers-up in the normal operation with the standby current of ICC1.

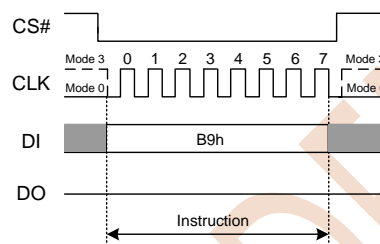

Figure 7.27 Deep Power-down Instruction

7.5.2 Release Power-down / Device ID (ABh)

The Release from Power-down / Device ID instruction is a multi-purpose instruction. It can be used to release the device from the power-down state, obtain the devices electronic identification (ID) number or both.

To release the device from the power-down state, the instruction is issued by driving the CS# pin low, shifting the instruction code “ABh” and driving CS# high as shown in Figure 7.28. After the time duration of t_{RES1} (See AC Characteristics) the device will resume normal operation and other instructions will be accepted. The CS# pin must remain high during the t_{RES1} time duration.

When used only to obtain the Device ID during the non-power-down state, the instruction is initiated by driving the CS# pin low and shifting the instruction code “ABh” followed by 3-dummy bytes. The Device ID bits will then be shifted out on the falling edge of CLK with most significant bit (MSB) first as shown in Figure 7.29. The Device ID value for the ZB25VQ80A is listed in Manufacturer and Device Identification table. The Device ID can be read continuously. The instruction is completed by driving CS# high.

When used to release the device from the power-down state and obtain the Device ID, the instruction is the same as previously described, and shown in Figure 7.29, except that after CS# is driven high it must remain high for a time duration of t_{RES2} (See AC Characteristics). After this time duration the device will resume normal operation and other instructions will be accepted. If the Release from Power-down / Device ID instruction is issued within Erase, Program or Write cycle (when BUSY equals 1), the instruction is ignored and will not have any effects on the current cycle.

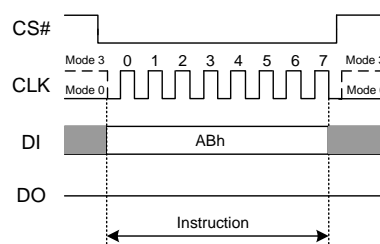

Figure 7.28 Release Power-down Instruction

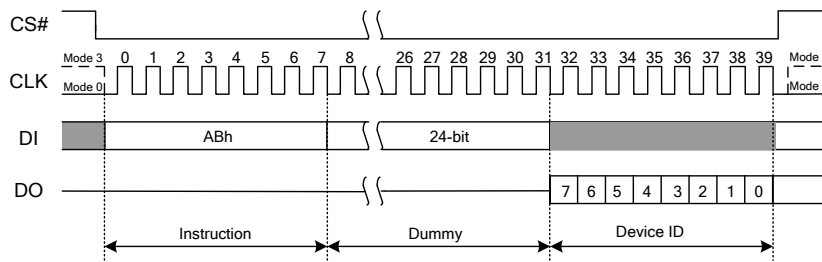

Figure 7.29a Release Power-down / Device ID

7.5.3 Read Manufacturer / Device ID (90h)

The Read Manufacturer/Device ID instruction is an alternative to the Release from Power-down/Device ID instruction that provides both the JEDEC assigned manufacturer ID and the specific device ID.

The Read Manufacturer/Device ID instruction is very similar to the Release from Power-down / Device ID instruction. The instruction is initiated by driving the CS# pin low and shifting the instruction code “90h” followed by a 24-bit address (A23-A0) of 000000h. After which, the Manufacturer ID and the Device ID are shifted out on the falling edge of CLK with most significant bit (MSB) first as shown in Figure 7.30. If the 24-bit address is initially set to 000001h the Device ID will be read first and then followed by the Manufacturer ID. The Manufacturer and Device IDs can be read continuously, alternating from one to the other. The command is completed by driving CS# high.

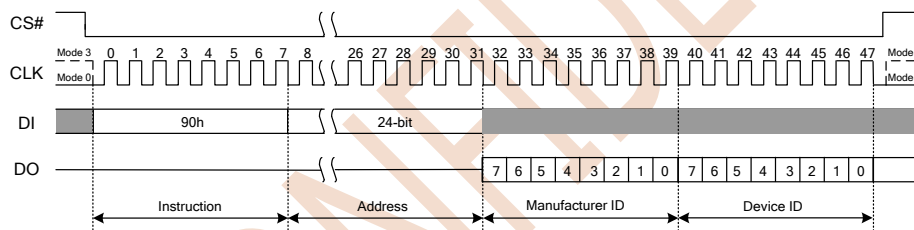

Figure 7.30a Read Manufacturer/Device ID

7.5.4 Read Identification (RDID) (9Fh)

For compatibility reasons, the ZB25VQ80A provides several instructions to electronically determine the identity of the device. The Read JEDEC ID instruction is compatible with the JEDEC standard for SPI compatible serial memories that was adopted in 2003.

The instruction is initiated by driving the CS# pin low and shifting the instruction code “9Fh”. The JEDEC assigned Manufacturer ID byte and two Device ID bytes, Memory Type (ID15-ID8) and Capacity (ID7-ID0) are then shifted out on the falling edge of CLK with most significant bit (MSB) first as shown in Figure 7.31. For memory type and capacity values, refer to Manufacturer and Device Identification table.

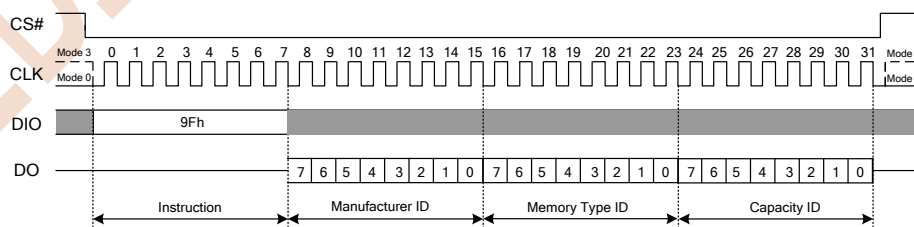

Figure 7.31a Read JEDEC ID

7.5.5 Read SFDP Register (5Ah)

The Read SFDP command is initiated by driving the CS# pin low and shifting the instruction code “5Ah” followed by a 24-bit address (A23-A0) into the DI pin. Eight “dummy” clocks are also required before the SFDP register contents are shifted out on the falling edge of the 40th CLK with most significant bit (MSB) first



as shown in Figure 7.32.

Note: A23-A8 = 0; A7-A0 are used to define the starting byte address for the 256-byte SFDP Register.

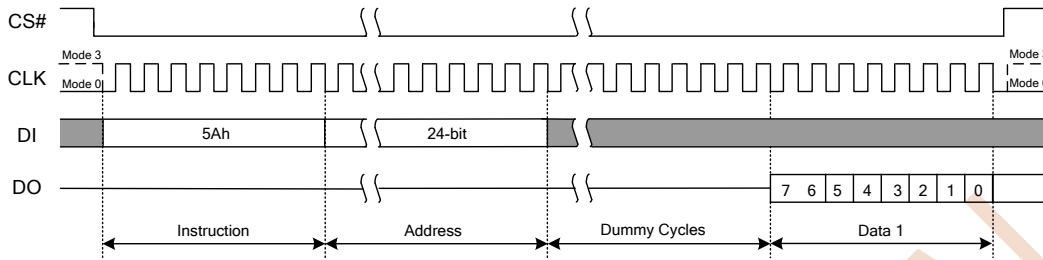

Figure 7.32 Read SFDP Register Instruction

7.5.6 Erase Security Registers (44h)

The ZB25VQ80A offers three 256-byte Security Registers which can be erased and programmed individually. These registers may be used by system manufacturers to store security and other important information separately from the main memory array.

The Erase Security Register command is similar to the Sector Erase command. A Write Enable command must be executed before the device will accept the Erase Security Register Command (Status Register bit WEL must equal to 1). The command is initiated by driving the CS# pin low and shifting the instruction code “44h” followed by a 24-bit address (A23-A0) to erase one of the security registers.

Address	A23-16	A15-8	A7-0
Security Register-1	00h	10h	xxh
Security Register-2	00h	20h	xxh
Security Register-3	00h	30h	xxh

Note:

1. Addresses outside the ranges in the table have undefined results.

The Erase Security Register command sequence is shown in Figure 7.33. The CS# pin must be driven high after the eighth bit of the last byte has been latched. If this is not done the command will not be executed. After CS# is driven high, the self-timed Erase Security Register operation will commence for a time duration of t_{SE} (see Section 8.5, AC Electrical Characteristics). While the Erase Security Register cycle is in progress, the Read Status Register command may still be accessed for checking the status of the BUSY bit. The BUSY bit is a 1 during the erase cycle and becomes a 0 when the cycle is finished and the device is ready to accept other commands again. After the Erase Security Register cycle has finished the Write Enable Latch (WEL) bit in the Status Register is cleared to 0. The Security Register Lock Bits (LB[3:1]) in the Status Register-2 can be used to OTP protect the security registers. Once a lock bit is set to 1, the corresponding security register will be permanently locked, and an Erase Security Register command to that register will be ignored.

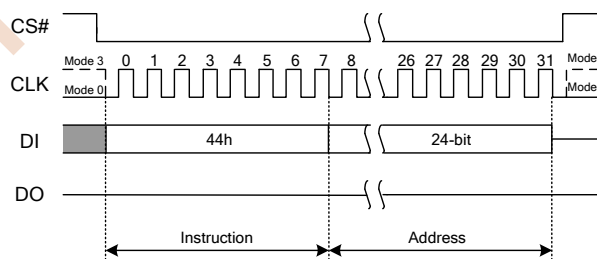

Figure 7.33 Erase Security Registers Instruction

7.5.7 Program Security Registers (42h)

The Program Security Register command is similar to the Page Program command. It allows from one byte to 256 bytes of security register data to be programmed at previously erased (FFh) memory locations. A Write Enable command must be executed before the device will accept the Program Security Register Command (Status Register bit WEL= 1). The command is initiated by driving the CS# pin low then shifting the instruction code “42h” followed by a 24-bit address (A23-A0) and at least one data byte, into the DI pin. The



CS# pin must be held low for the entire length of the command while data is being sent to the device.

Address	A23-16	A15-8	A7-0
Security Register-1	00h	10h	Byte Address
Security Register-2	00h	20h	Byte Address
Security Register-3	00h	30h	Byte Address

Note:

- Addresses outside the ranges in the table have undefined results.

The Program Security Register command sequence is shown in Figure 7.34. The Security Register Lock Bits (LB3:1) in the Status Register-2 can be used to OTP protect the security registers. Once a lock bit is set to 1, the corresponding security register will be permanently locked, and a Program Security Register command to that register will be ignored.

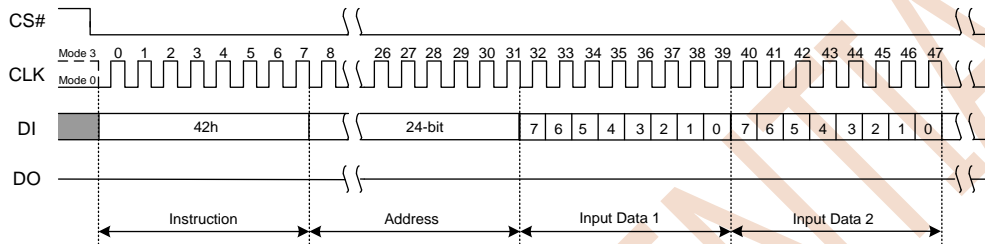

Figure 7.34 Program Security Registers Instruction

7.5.8 Read Security Registers (48h)

The Read Security Register command is similar to the Fast Read command and allows one or more data bytes to be sequentially read from one of the three security registers. The command is initiated by driving the CS# pin low and then shifting the instruction code “48h” followed by a 24-bit address (A23-A0) and eight “dummy” clocks into the DI pin. The code and address bits are latched on the rising edge of the CLK pin. After the address is received, and following the eight dummy cycles, the data byte of the addressed memory location will be shifted out on the DO pin at the falling edge of CLK with most significant bit (MSB) first. Locations with address bits A23-A16 not equal to zero, have undefined data. The byte address is automatically incremented to the next byte address after each byte of data is shifted out. Once the byte address reaches the last byte of the register (FFh), it will reset to the first byte of the register (00h) and continue to increase. The command is completed by driving CS# high. The Read Security Register command sequence is shown in Figure 7.35. If a Read Security Register command is issued while an Erase, Program, or Write cycle is in process (BUSY=1), the command is ignored and will not have any effects on the current cycle. The Read Security Register command allows clock rates from DC to a maximum of F_R (see Section 8.5, AC Electrical Characteristics).

Address	A23-16	A15-8	A7-0
Security Register-1	00h	10h	Byte Address
Security Register-2	00h	20h	Byte Address
Security Register-3	00h	30h	Byte Address

Note:

- Addresses outside the ranges in the table have undefined results.

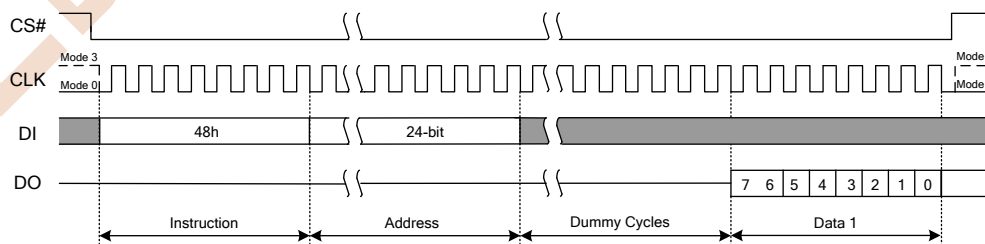

Figure 7.35 Read Security Registers Instruction

7.5.9 Read Manufacturer / Device ID Dual I/O (92h)

The Read Manufacturer / Device ID Dual I/O instruction is an alternative to the Read Manufacturer /



Device ID instruction that provides both the JEDEC assigned manufacturer ID and the specific device ID at 2x speed.

The Read Manufacturer / Device ID Dual I/O instruction is similar to the Fast Read Dual I/O instruction. The instruction is initiated by driving the CS# pin low and shifting the instruction code "92h" followed by a 24-bit address (A23-A0) of 000000h, but with the capability to input the Address bits two bits per clock. After which, the Manufacturer ID and the Device ID are shifted out 2 bits per clock on the falling edge of CLK with most significant bits (MSB) first as shown in Figure 7.36. The Device ID values for the ZB25VQ80A are listed in Manufacturer and Device Identification table. The Manufacturer and Device IDs can be read continuously, alternating from one to the other. The instruction is completed by driving CS# high.

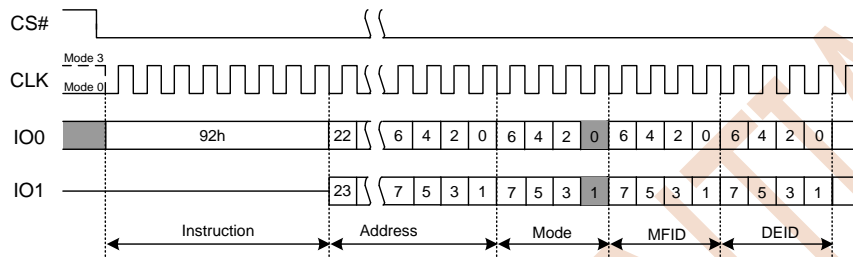

Figure 7.36 Read Manufacturer/Device ID Dual I/O Instruction

Note:

- 1. The "Continuous Read Mode" bits M7-0 must be set to Fxh to be compatible with Fast Read Dual I/O instruction.

7.5.10 Read Manufacturer / Device ID Quad I/O (94h)

The Read Manufacturer / Device ID Quad I/O instruction is an alternative to Read Manufacturer / Device ID instruction that provides both the JEDEC assigned manufacturer ID and the specific device ID at 4 x speeds.

The Read Manufacturer / Device ID Quad I/O instruction is similar to the Fast Read Quad I/O instruction. The instruction is initiated by driving the CS# pin low and shifting the instruction code "94h" followed by a 24-bit address(A23-A0) of 000000h, 8-bit Continuous Read Mode Bits and then four clock dummy cycles, with the capability to input the Address bits four bits per clock. After that, the Manufacturer ID and the Device ID are shifted out four bits per clock on the falling edge of CLK with most significant bit (MSB) first as shown in Figure 7.37. The Device ID values for ZB25VQ80A are listed in Manufacturer and Device Identification table. The Manufacturer and Device IDs can be read continuously, alternating from one to the other. The instruction is completed by driving CS# high.

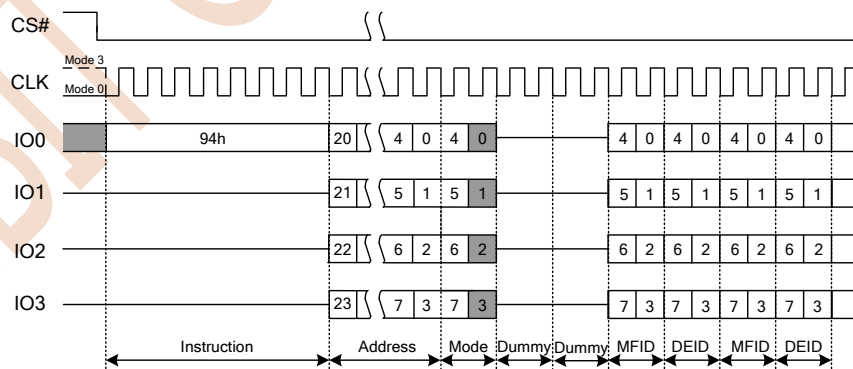

Figure 7.37 Read Manufacturer/Device ID Quad I/O Instruction

Note:

- 1. The "Continuous Read Mode" bits M7-0 must be set to Fxh to be compatible with Fast Read Quad I/O instruction.

7.5.11 Read Unique ID Number (4Bh)

The Read Unique ID Number instruction accesses a factory-set read-only 64-bit number which is unique



to each ZB25VQ80A device. The ID number can be used in conjunction with user software methods to help prevent copying or cloning of a system. The Read Unique ID instruction is initiated by driving the CS# pin low and shifting the instruction code "4Bh" followed by four bytes dummy clocks. After that, the 64-bit ID is shifted out on the falling edge of CLK as shown in Figure 7.38.

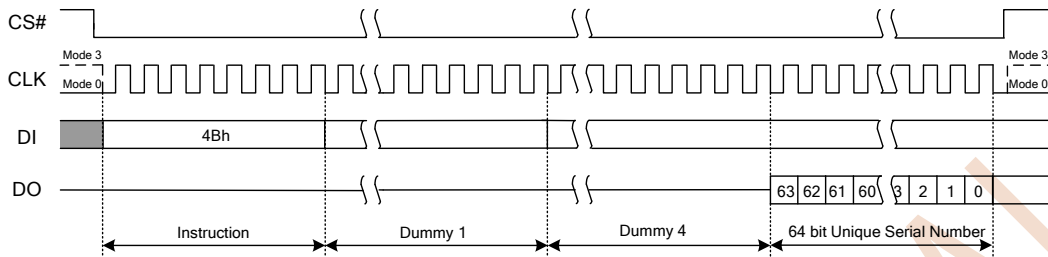

Figure 7.38 Read unique ID Number Instruction



8. ELECTRICAL CHARACTERISTIC

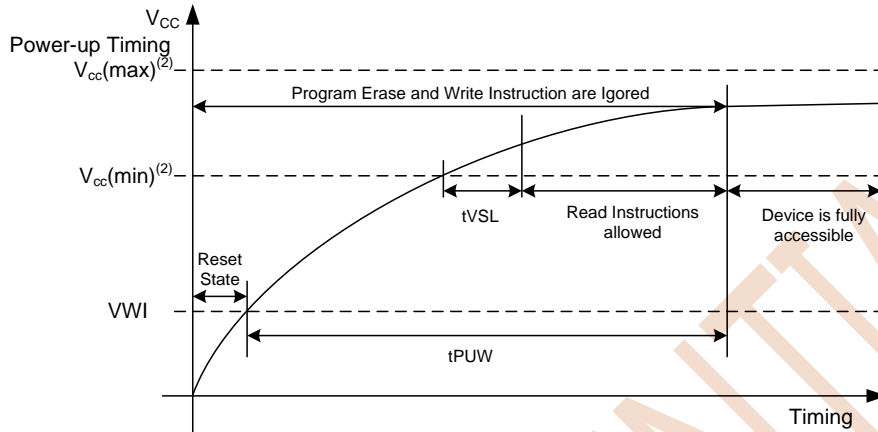

Figure 8.1 Power-up Timing

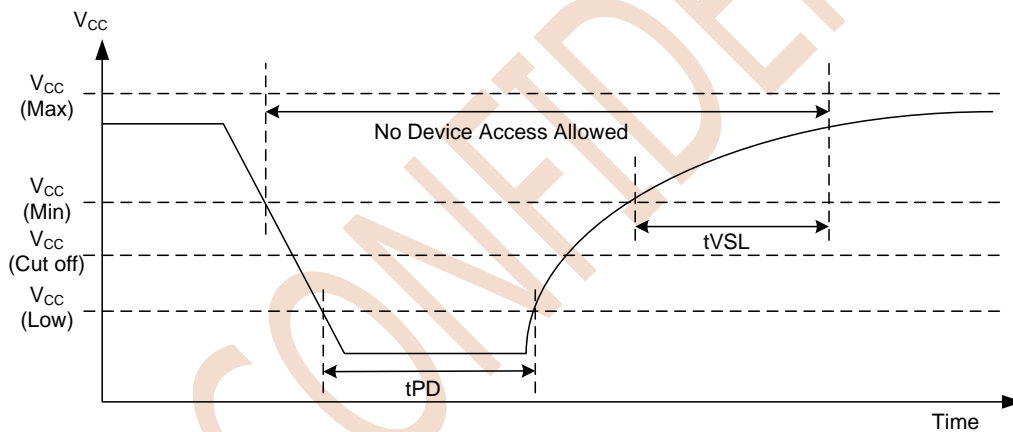

Figure 8.2 Power-Down and Voltage Drop

Table 8.1 Power-up and Power-down Timing

PARAMETER	SYMBOL	TYPE		UNIT
		MIN	MAX	
V_{CC} (minimum operation voltage)	$V_{CC(min)}$	2.3	-	V
V_{CC} (cut off where re-initialization is needed)	$V_{CC(cut\ off)}$	2.1	-	V
V_{CC} (low voltage for initialization to occur)	$V_{CC(low)}$	1.0	-	V
V_{CC} (min) to CS# Low	$t_{VSL}^{(1)}$	10	-	μs
Time Delay Before Write Instruction	$t_{PUW}^{(1)}$	1	10	ms
V_{CC} (low) time	t_{PD}	10	-	μs
Write Inhibit Threshold Voltage	$V_{WI}^{(1)}$	1	2	V

Notes:

- (1) The parameters are characterized only.
- (2) V_{CC} (max.) is 3.6V and V_{CC} (min.) is 2.3V.



8.1. Absolute Maximum Ratings

Stresses above the values mentioned as following may cause permanent damage to the device. These values are for a stress rating only and do not imply that the device should be operated at conditions up to or above these values.

Table 8.2⁽¹⁾ Absolute Maximum Rating

PARAMETERS ⁽²⁾	SYMBOL	CONDITIONS	RANGE	UNIT
Supply Voltage	V _{CC}		-0.6 to +4.0	V
Voltage applied on any pin	V _{IO}	Relative to Ground	-0.6 to V _{CC} +0.4	V
Transient Voltage on any Pin	V _{IO} T	<20ns Transient Relative to Ground	-2.0 to V _{CC} +2.0	V
Storage Temperature	T _{STG}		-65 to +150	°C
Lead Temperature	T _{LEAD}		See Note ⁽³⁾	°C
Electrostatic Discharge Voltage	V _{ESD}	Human Body Model ⁽⁴⁾	-2000 to +2000	V

Notes:

(1) Specification for ZB25VQ80A is preliminary. See preliminary designation at the end of this document.

(2) This device has been designed and tested for the specified operation ranges. Proper operation outside these levels is not guaranteed. Exposure to absolute maximum ratings may affect device reliability. Exposure beyond absolute maximum ratings may cause permanent damage.

(3) Compatible to JEDEC Standard J-STD-20C for small body Sn-Pb or Pb-free (Green) assembly and the European directive on restrictions on hazardous substances (RoHS) 2002/95/EU.

(4) JEDEC Std. JESD22-A114A (C1=100 pF, R1=1500 ohms, R2=500 ohms).

8.2. Recommended Operating Ranges

Table 8.3 Recommended Operating Ranges

PARAMETER	SYMBOL	CONDITIONS	SPEC		UNIT
			MIN	MAX	
Supply Voltage	V _{CC} ⁽¹⁾	F _R =104MHz, f _R =80MHz	2.7	3.6	V
		F _R =80MHz, f _R =50MHz	2.3	2.7	V
Ambient Temperature, Operating	T _A	Industrial	-40	85	°C

Notes:

(1) Recommended Operating Ranges define those limits between which the functionality of the device is guaranteed.



8.3. DC Characteristics

Table 8.4 DC Characteristics

SYMBOL	PARAMETER	CONDITIONS	SPEC			UNIT
			MIN	TYP	MAX	
CIN ⁽¹⁾	Input Capacitance	VIN = 0V ⁽²⁾			6	pF
COU ⁽¹⁾	Output Capacitance	VOU = 0V ⁽²⁾			8	pF
ILI	Input Leakage				±2	uA
ILO	I/O Leakage				±2	uA
ICC1	Standby Current, HFM=0	CS# = V _{CC} , VIN= GND or V _{CC}		12	25	uA
ICC8	Standby Current, HFM=1	CS# = V _{CC} , VIN= GND or V _{CC}		25	40	uA
ICC2	Power-down Current	CS# = V _{CC} , VIN= GND or V _{CC}		2	5	uA
ICC3	Current Read Data / Dual/Quad Output Read 50MHz ⁽²⁾	C = 0.1 V _{CC} / 0.9 V _{CC} DO = Open			9	mA
ICC3	Current Read Data / Dual/Quad Output Read 80MHz ⁽²⁾	C = 0.1 V _{CC} / 0.9 V _{CC} DO = Open			12	mA
ICC3	Current Read Data / Dual/Quad Output Read 104MHz ⁽²⁾	C = 0.1 V _{CC} / 0.9 V _{CC} DO = Open			15	mA
ICC4	Current Page Program	CS# = V _{CC}		12	20	mA
ICC5	Current Write Status Register	CS# = V _{CC}		3	15	mA
ICC6	Current Sector Erase	CS# = V _{CC}		9	20	mA
ICC7	Current Chip/Block Erase	CS# = V _{CC}		15	25	mA
VIL	Input Low Voltage		-0.5		0.6	V
VIH	Input High Voltage		V _{CC} ×0.7			V
VOL	Output Low Voltage	IOL = 100 uA			0.2	V
VOH	Output High Voltage	IOH = - 100 uA	V _{CC} - 0.2			V

Notes:

(1) Tested on sample basis and specified through design and characterization data. T_A=25° C, V_{CC}=3V.

(2) Checker Board Pattern.

8.4. AC Measurement Conditions

Table 8.5 AC Measurement Conditions

Symbol	PARAMETER	Min.	Max.	Unit
CL	Load Capacitance		30	pF
TR, TF	Input Rise and Fall Times		5	ns
VIN	Input Pulse Voltages	0.2V _{CC} to 0.8V _{CC}		V
VtIN	Input Timing Reference Voltages	0.3V _{CC} to 0.7V _{CC}		V
VtON	Output Timing Reference Voltages	0.5 V _{CC} to 0.5 V _{CC}		V

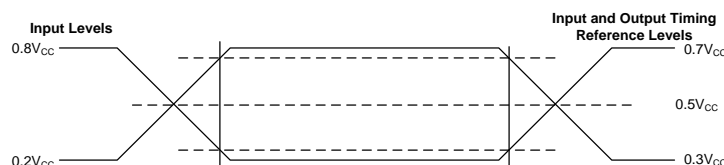

Figure 8.3 AC Measurement I/O Waveform



8.5. AC Electrical Characteristics

Table 8.6 AC Electrical Characteristics

SYMBOL	ALT	Parameter	SPEC			UNIT
			MIN	TYP	MAX	
F _R	f _c	Clock frequency for all SPI, Dual, Quad IO instructions with HFM (except 03h), V _{CC} =3.0V-3.6V	D.C.		120	MHz
F _R	f _c	Clock frequency for all SPI, Dual, Quad IO instructions with HFM (except 03h), V _{CC} =2.7V-3.0V	D.C.		104	MHz
F _R	f _c	Clock frequency for all SPI, Dual, Quad IO instructions with HFM (except 03h), V _{CC} =2.3V-2.7V ⁽¹⁾	D.C.		80	MHz
f _R		Clock frequency for Read Data instruction (03h) 2.3V-3.6V V _{CC}	D.C.		55	MHz
t _{CLH} , t _{CLL} ⁽¹⁾		Clock High, Low Time for all instructions except Read Data (03h)	4			ns
t _{CRLH} , t _{CRLL} ⁽¹⁾		Clock High, Low Time for Read Data (03h) instruction	6			ns
t _{CLCH} ⁽²⁾		Clock Rise Time peak to peak	0.1			V/ns
t _{CHCL} ⁽²⁾		Clock Fall Time peak to peak	0.1			V/ns
t _{SLCH}	t _{CSS}	CS# Active Setup Time relative to CLK	5			ns
t _{CHSL}		CS# Not Active Hold Time relative to CLK	5			ns
t _{DVCH}	t _{DSU}	Data In Setup Time	2			ns
t _{CHDX}	t _{DH}	Data In Hold Time	5			ns
t _{CHSH}		CS# Active Hold Time relative to CLK	5			ns
t _{SHCH}		CS# Not Active Setup Time relative to CLK	5			ns
t _{SHSL1}	t _{CSH}	CS# Deselect Time for Array Read→Array Read	100			ns
t _{SHSL2}	t _{CSH}	CS# Deselect Time for Erase/Program→Read SR Volatile Status Register Write Time	50			ns
t _{SHOZ} ⁽²⁾	t _{DIS}	Output Disable Time			7	ns
t _{CLQV}	t _V	Clock Low to Output Valid 2.7V- 3.6V			7	ns
t _{CLQV}	t _V	Clock Low to Output Valid 2.3V- 2.7V			9	ns
t _{CLQX}	t _{HO}	Output Hold Time	2			ns
t _{HLCH}		HOLD# Active Setup Time relative to CLK	5			ns
t _{CHHH}		HOLD# Active Hold Time relative to CLK	5			ns
t _{HHCH}		HOLD# Not Active Setup Time relative to CLK	5			ns
t _{CHHL}		HOLD# Not Active Hold Time relative to CLK	5			ns
t _{HHQX}	t _{LZ} ⁽²⁾	HOLD# to Output Low-Z			7	ns
t _{HLQZ}	t _{HZ} ⁽²⁾	HOLD# to Output High-Z			12	ns
t _{WHSL} ⁽³⁾		Write Protect Setup Time Before CS# Low	20			ns
t _{SHWL} ⁽³⁾		Write Protect Hold Time After CS# High	100			ns
t _{DP} ⁽²⁾		CS# High to Power-down Mode			3	μs
t _{RES1} ⁽²⁾		CS# High to Standby Mode without Electronic Signature Read			8	μs
t _{RES2} ⁽²⁾		CS# High to Standby Mode with Electronic Signature Read			6	μs
t _{SUS} ⁽²⁾		CS# High to next Command after Suspend			20	μs
t _W		Write Status Register Time		10	100	ms
t _{PP}		Page Program Time		0.6	3	ms
t _{SE}		Sector Erase Time (4KB)		40	400	ms
t _{BE1}		Block Erase Time (32KB)		150	1600	ms
t _{BE2}		Block Erase Time (64KB)		200	2000	ms
t _{CE}		Chip Erase Time		3	10	s
t _{RCH} ⁽²⁾		End of Reset Instruction to CE# High	40			ns
t _{RST} ⁽²⁾		CE# High to next Instruction after Reset			20	μs

Notes:

- (1) Clock high + Clock low must be less than or equal to 1/f_c.
(2) Value guaranteed by design and/or characterization, not 100% tested in production.
(3) Only applicable as a constraint for a Write Status Register instruction when SRP0 = 1.

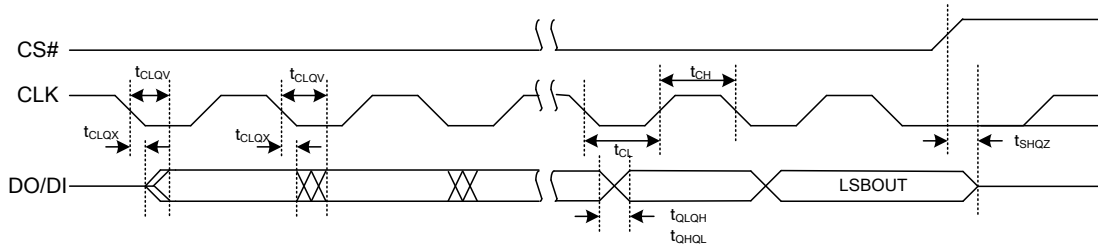

*DIO IS AN OUTPUT ONLY FOR THE FAST READ DUAL OUTPUT INSTRUCTIONS (3BH)

Figure 8.4 Serial Output Timing

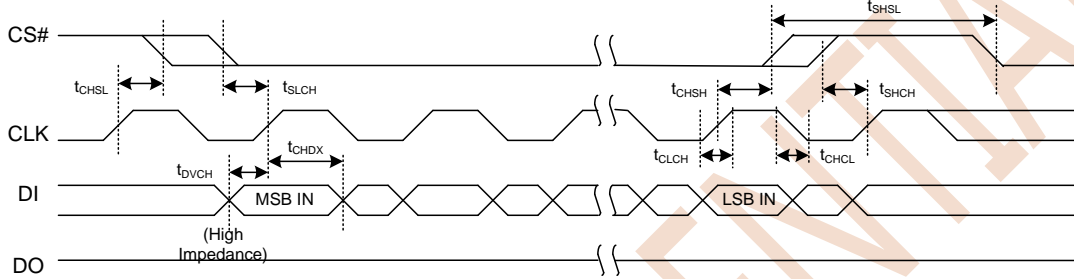

Figure 8.5 Input Timing

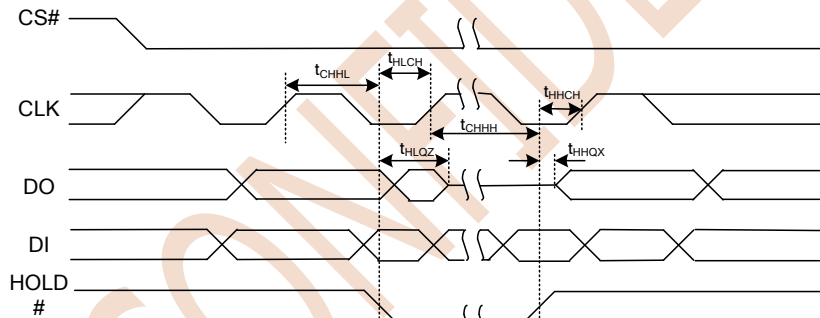

Figure 8.6 Hold Timing

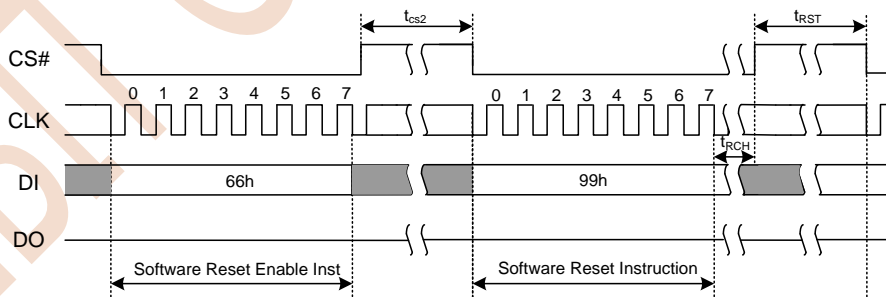

Figure 8.7 Software Reset Input Timing



9. PACKAGE MECHANICAL

9.1. Valid Part Numbers

Please contact Zbit regional sales for the latest product selection and available from factors.

Product Number	Density	Package Type	Temperature
ZB25VQ80APIG	8Mbit	DIP8-300mil	-40 ~ 85°C
ZB25VQ80ATIG	8Mbit	SOP8-150mil	-40 ~ 85°C
ZB25VQ80ASIG	8Mbit	SOP8-208mil	-40 ~ 85°C
ZB25VQ80AVIG	8Mbit	VSOP8-208mil	-40 ~ 85°C
ZB25VQ80AOIG	8Mbit	TSSOP8-173mil	-40 ~ 85°C
ZB25VQ80ADIG	8Mbit	DFN8 (2*3mm)	-40 ~ 85°C
ZB25VQ80AZIG	8Mbit	TFBGA24 (5*5 Ball Array)	-40 ~ 85°C
ZB25VQ80ABIG	8Mbit	TFBGA24 (6*4 Ball Array)	-40 ~ 85°C

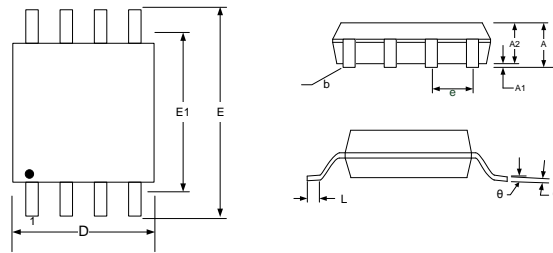
9.2. SOP8 - 150mil

SYMBOL	MILIMETERS			INCHES		
	MIN	TYP	MAX	MIN	TYP	MAX
A	---	---	1.75	---	---	0.069
A1	0.05	0.15	0.25	0.002	0.006	0.010
A2	1.25	1.40	1.55	0.049	0.055	0.061
b	0.31	0.41	0.51	0.012	0.016	0.020
C	0.15	0.20	0.25	0.006	0.008	0.010
D	4.80	4.90	5.00	0.1890	0.193	0.197
E	5.80	6.00	6.20	0.228	0.236	0.244
E1	3.80	3.90	4.00	0.150	0.154	0.157
e	---	1.27BSC	---	---	0.05BSC	---
L	0.40	---	0.80	0.016	---	0.031
θ	0°	---	8°	---	---	---

Note:

- (1) Both the package length and width do not include the mold flash.
- (2) Seating plane: Max. 0.1mm.

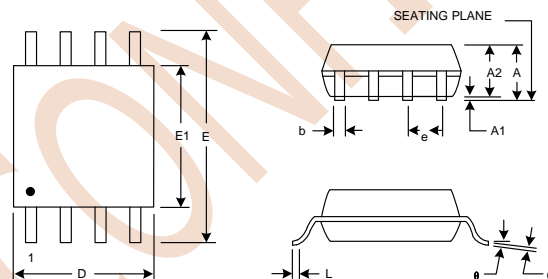
9.3. SOP8 - 208mil

SYMBOL	MILIMETERS			INCHES		
	MIN	TYP	MAX	MIN	TYP	MAX
A	---	---	2.15	---	---	0.085
A1	0.05	0.15	0.25	0.002	0.006	0.010
A2	1.70	1.80	1.91	0.067	0.071	0.075
b	0.31	0.41	0.51	0.012	0.016	0.020
C	0.15	0.20	0.25	0.006	0.008	0.010
D	5.13	5.23	5.33	0.202	0.206	0.210
E	7.70	7.90	8.10	0.303	0.311	0.319
E1	5.18	5.28	5.38	0.204	0.208	0.212
e	---	1.27BSC	---	---	0.05BSC	---
L	0.50	0.65	0.80	0.020	0.03	0.031
θ	0°	---	8°	0°	---	8°

Note:

- (1) Both the package length and width do not include the mold flash.
- (2) Seating plane: Max. 0.1mm.



9.4. TFBGA24 (5*5 Ball Array)

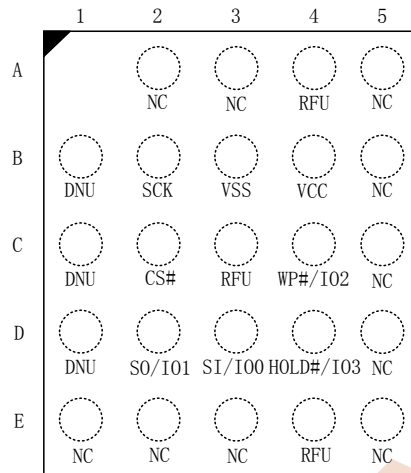

9.5. TFBGA24 (6*4 Ball Array)

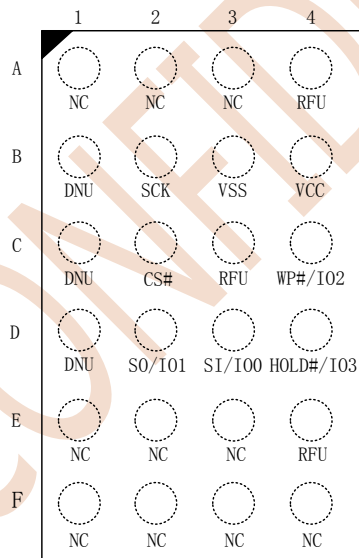



9.6. TSSOP8 - 173mil

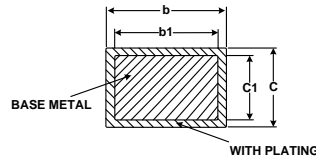
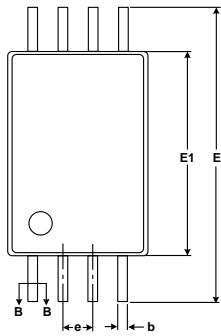
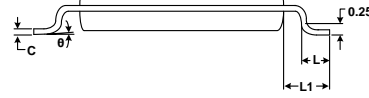
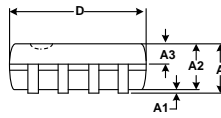

SYMBOL	MILLIMETER		
	MIN	NOM	MAX
A	-	-	1.20
A1	0.05	-	0.15
A2	0.90	1.00	1.05
A3	0.39	0.44	0.49
b	0.20	-	0.28
b1	0.19	0.22	0.25
c	0.13	-	0.17
c1	0.12	0.13	0.14
D	2.90	3.00	3.10
E1	4.30	4.40	4.50
E	6.20	6.40	6.60
e	0.65BSC		
L	0.45	-	0.75
L1	1.00REF		
theta	0	-	8°

Note:

- (1) Both the package length and width do not include the mold flash.
- (2) Seating plane: Max. 0.1mm.

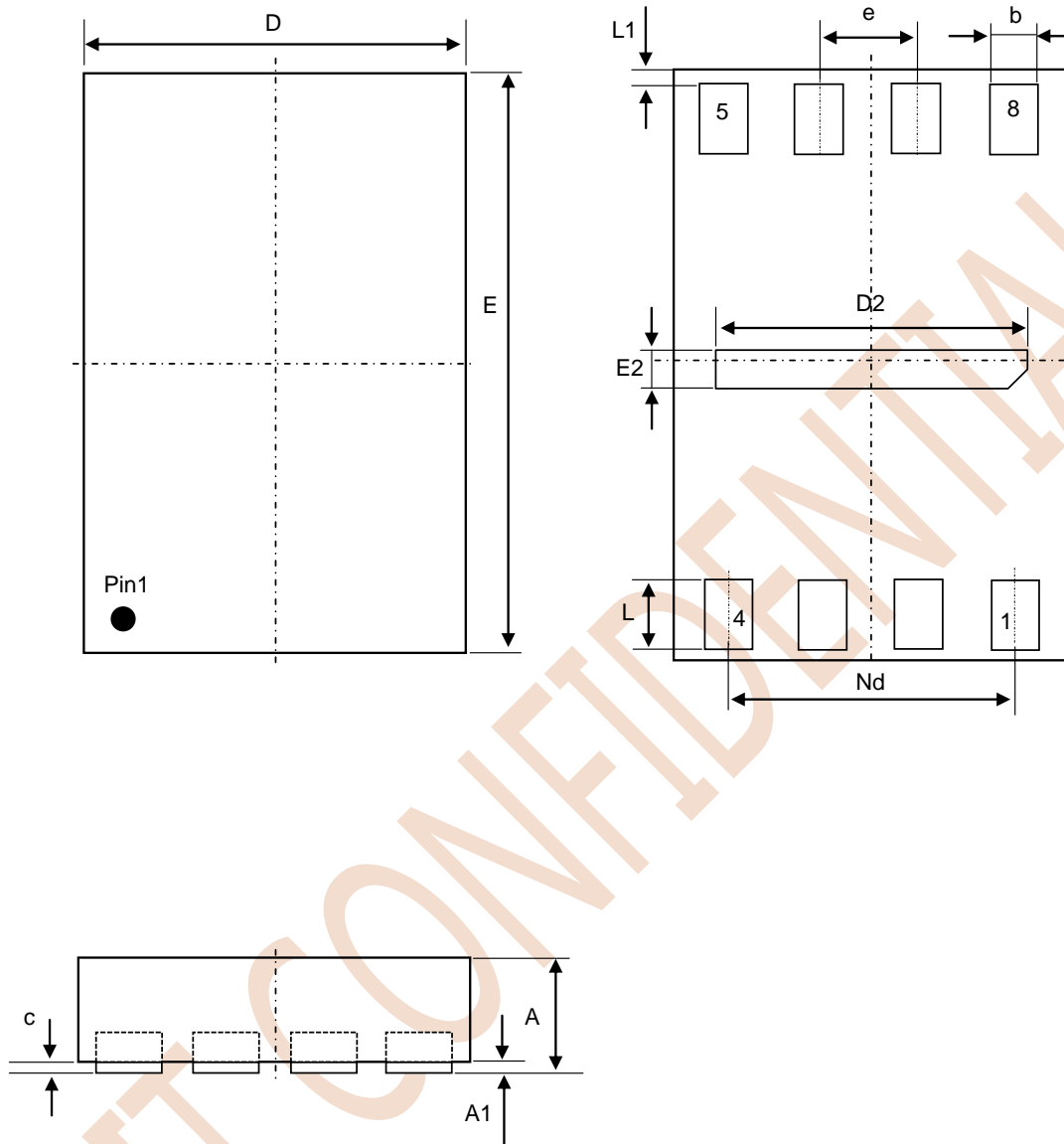
9.7. DFN8 (2*3*0.55mm)

Dimensions :

Symbol		A	A1	b	c	D	D2	e	Nd	E	E2	L	L1
Unit		mm											
Min		0.50	0	0.18	0.10	1.90	1.50	0.50 REF	1.50 REF	2.90	0.10	0.30	0.05
Nom		0.55	0.02	0.25	0.15	2.00	1.60			3.00	0.20	0.35	0.10
Max		0.60	0.05	0.30	0.20	2.10	1.70			3.10	0.30	0.40	0.15

Note:

- Both the package length and width do not include the mold flash.
- The exposed metal pad area on the bottom of the package is floating.
- Coplanarity $\leq 0.08\text{mm}$. Package edge tolerance $\leq 0.10\text{mm}$.
- The lead shape may be of little difference according to different package factories. These lead shapes are compatible with each other.

**REVISION LIST**

Version No.	Description	Date
A	Initial Release	2018/01/15
B	Change Table 8.6	2018/07/24
C	Add Package TSSOP	2018/10/23
D	Add Package	2018/10/30
E	Change Package type	2018/10/31
F	Change Instruction	2018/11/12
G	Change Package	2018/11/28
H	Change Table 8.4 DC Characteristics and Table 8.6 AC Characteristics	2019/04/01
I	Change Status Register-2	2019/07/09
J	Adopting new version naming rule	2019/07/31
K	Change Table 8.6 AC Characteristics	2019/11/21
L	Change Package SOP8 DOP parameter and ORDERING	2020/04/03
M	Add Valid Part Number	2020/05/09